

BeL'M

HAUSTÜREN
ENTRANCE DOORS
PORTES D'ENTRÉE

2020



100% fabrication française

Bel'M

WIR LEBEN FÜR UNSERE PRODUKTE
IT'S A STATE OF MIND
C'EST UN ÉTAT D'ESPRIT

1300 Mitarbeiter
Employees
Personnes



Sozialverantwortliches
Engagement
Responsible commitment
Engagement responsable





7 Fertigungsstandorte
Manufacturing plants
Sites industriels



INHALTS

CONTENTS

SOMMAIRE

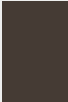
	ALUMINIUM	10
	ALUSTAHL ALUSTEEL ACIER	62
	HOLZ TIMBER BOIS	100
	ZUBEHÖR & OPTIONEN ACCESSORIES & OPTIONS ACCESSOIRES & OPTIONS	115



Handwerkliches Know-how
Expert craftsmanship
Savoir-faire artisanal



French Touch

Widerstandsklasse RC2
RC2 certified safety
Sécurité RC2

DIE SICHERHEIT

SECURITY

SÉCURITÉ



Unsere Aluminiumtüren sind standardmäßig RC2-zertifiziert.* Optional auch in Stahl und Holz erhältlich.

Our Aluminium doors are RC2 certified as standard.* Also available as an option for the Alusteel and Timber ranges.

Nos portes aluminium sont certifiées RC2 en standard.* Disponible en option également sur les gammes acier et bois.



Innenansicht / Inside view /
Vue intérieure



Außenansicht / Outside view /
Vue extérieure

01



02



Aluminium



AluStahl / Alusteel / Acier

03

Die Sicherheitsmerkmale im Detail
Details of security features
Détail des équipements de sécurité

* außer mit A-129 und A-130 Modelle
* except on A-129 and A-130 models
* excepté modèles A-129 et A-130

WARRANTY



SCHLOSS
LOCKING SYSTEM
SERRURE



Unsere Türen wurden vom IFT Rosenheim geprüft und gemäß der Norm EN 1627 für die Klasse 2 hinsichtlich der Einbruchschutz zertifiziert.

Our entrance doors have been tested by IFT Rosenheim and are class 2 certified as per EN 1627 standard in terms of high break-in resistance.

Nos portes ont été testées par l'IFT de Rosenheim en Allemagne et sont certifiées classe 2 selon la norme EN 1627 en termes de résistance à l'effraction.

	ALUMINIUM	AluStahl ALUSTEEL ACIER 48 & 68+
TÜRBÄNDER HINGES FICHES	01 3 dimensional verstellbar dimensional adjustable dimensions réglables	
AUTOMATIK-UND SICHERHEITSSCHLOSS AUTOMATIC SECURITY LOCKING SYSTEM SERRURE DE SÉCURITÉ AUTOMATIQUE	02 5 Punkte-Automatik point automatic points automatiques	2 Riegel bolts pènes + 1 Riegel deadbolt pêne dormant 2 Haken hooks crochets + Riegel 1/2 Umdrehung latch bolt pêne ½ tour
VERSTÄRKTER TÜRZYLINDER LOCK CYLINDER REINFORCEMENT RENFORT DE BARILLET	03 Edelstahl-Zylinderrosette mit durchgehender Befestigung. Stainless steel cylinder rosette with through-door fasteners. Rosace barillet inox avec fixation traversante.	Edelstahl-Zylinderrosette mit durchgehender Befestigung oder Sicherheitswechselgarnitur in Edelstahl mit Türzylinderschutz (Pos. 6 seite 118). Stainless steel cylinder rosette with through-door fasteners or stainless steel pull handle with cylinder reinforcement (see n°6 page 118). Rosace de barillet inox avec fixation traversante ou poignée de tirage inox avec protection de barillet (cf n°6 page 118).
SCHUTZZARGE MIT VERSTÄRKTER ALU-TÜRVERRIEGLUNG PROTECTIVE FRAME WITH ALUMINIUM STRIKE REINFORCEMENT DORMANT PROTECTEUR AVEC RENFORT DE GÂCHE EN ALUMINIUM		-

LEISTUNGEN

PERFORMANCE

PERFORMANCES

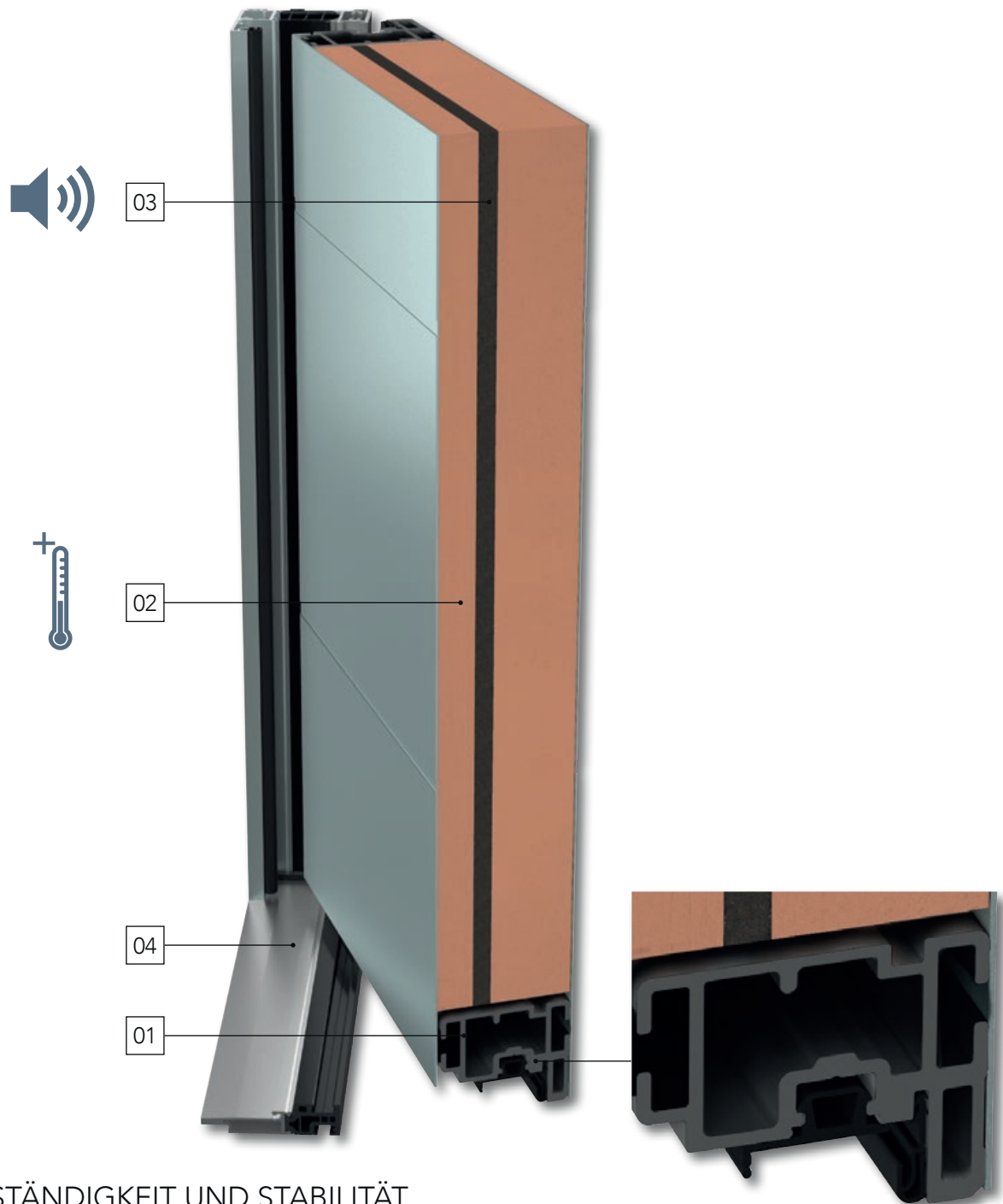

01 BESTÄNDIGKEIT UND STABILITÄT
DURABILITY AND STURDINESS
STABILITÉ ET RIGIDITÉ

Bis 2,50 m Höhe und/oder 1,20 m Breite. Garantie auf Formbeständigkeit <2 mm für Türen unter Extremstbedingungen (Temperatur -15° bis +70°C, dunkle Farbtöne).

Up to 2.50 m high and/or 1.20 m wide. Less than 2 mm distortion guaranteed for doors subjected to the most extreme conditions (-15° to +70°C temperatures and dark colours).

Jusqu'à 2,50 m de haut et/ou 1,20 m de large. Déformation garantie < 2 mm pour une porte soumise aux conditions les plus extrêmes (températures -15° à +70°C et couleurs foncées).



02 WÄRMEDÄMMUNG
THERMAL INSULATION
ISOLATION THERMIQUE

bis
up to
jusqu'à

Ud = 0,75

für Aluminium Stahltüre 68+
mit geschlossenem Türblatt
for a 68+ solid alusteel door
pour une porte pleine en acier 68+



03 SCHALLDÄMMUNG
ACOUSTIC INSULATION
ISOLATION ACOUSTIQUE

bis
up to
jusqu'à

Rw = 37 dB



04 DICHTIGKEIT
WEATHERPROOF
ÉTANCHÉITÉ

AEV

Luft - Wasser - Wind
Air - Water - Wind
Air - Eau - Vent

bis
up to
jusqu'à

A*4 E*6B V*C3

HAUSTECHNIK

SMART HOME TECHNOLOGY

DOMOTIQUE



Video auf Deutsch



Video in English



Vidéo en Français

Gönnen Sie sich den Komfort und die Sicherheit einer Bel'M-Tür mit motorisiertem Schloss in den Aluminium- und Holzreihen.

Enjoy comfort and peace of mind with Bel'M doors featuring motorized locking system on aluminium and timber ranges.

Profitez du confort et de la sérénité des portes Bel'M avec la serrure motorisée sur les gammes aluminium et bois.

■ ÖFFNUNG VOR DER TÜR / HANDS-FREE DOOR OPENING / OUVERTURE DEVANT LA PORTE



Arme unter Last
When you have your hands full
Bras chargés

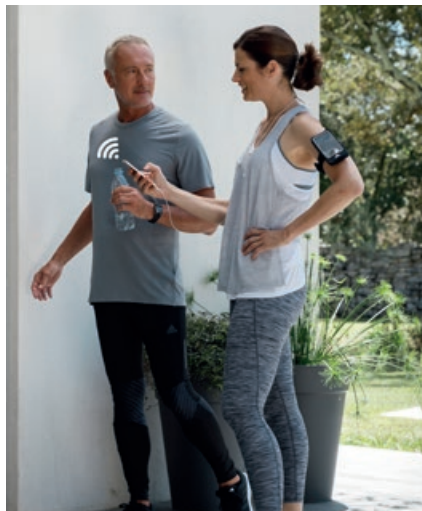

Schlüssellos
No keys
Sans clé



Mehrfachöffnung
Multiple doors
Multi-ouvertures

■ FERNÖFFNUNG / UNLOCKING REMOTELY / OUVERTURE À DISTANCE



Lieferanten, Handwerker, etc.
Deliveries, builders, etc.
Livraison, travaux, etc.



Familie, Kinder, Freunde
Family, children, friends
Famille, enfants, amis



Saisonale Vermietung
Seasonal rentals
Location saisonnière

6 SCHLOSSOPTIIONEN / 6 OPENING PACKS / 6 PACKS D'OUVERTURE



Smartphone
Smartphone
Smartphone



Berührungssensor
Hands-free
Mains libres



Funkfernbedienung
Radio control
Commandes



Funkschlüssel
Badges
Badges



Digicode
Keypad lock
Clavier à codes



Fingerabdruck
Fingerprints
Empreintes digitales

OPTIONEN / OPTIONS / OPTIONS



SOMFY
Micromodul-Empfänger für TaHoma
TaHoma micromodule receiver
Micromodule pour TaHoma



DELTA DORE
Micromodul-Empfänger für Tydom
Tydom micromodule receiver
Micromodule pour Tydom



Multifunktionsempfänger
Multifunction receiver
Récepteur multifonctions

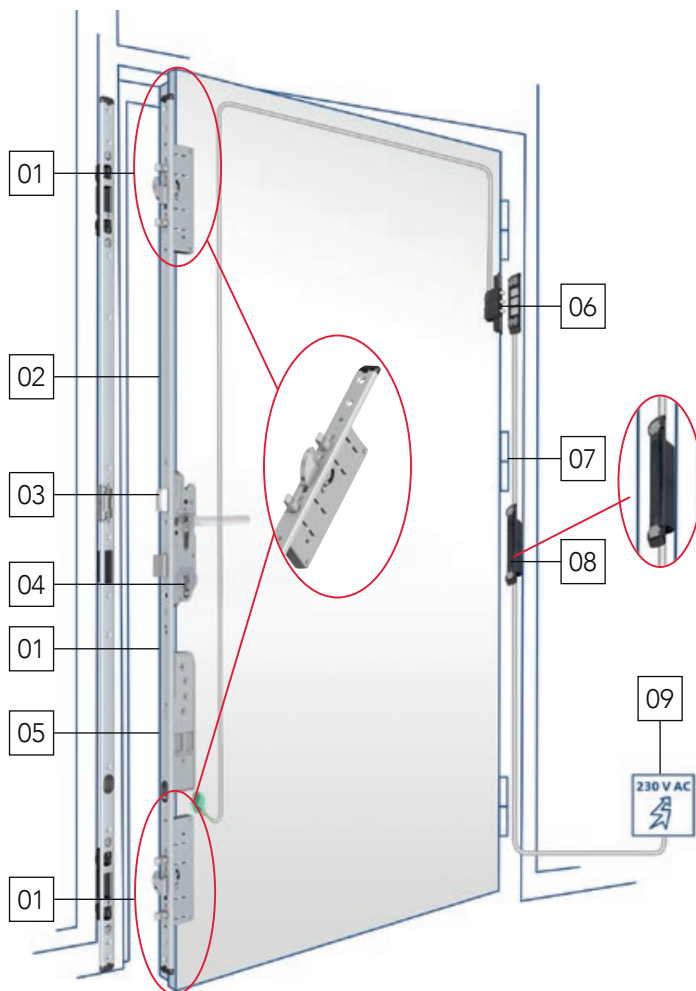

- 01 Motorisierte Verriegelungspunkte, im Türblatt integriert
Motorized latches built into the door
Points de fermeture motorisés intégrés à l'ouvrant
- 02 FlipLock mit Magnetkontakt
One-piece strike with magnetic contact
Gâche filante avec contact magnétique
- 03 Anti-Panik-Funktion
Anti-panic function
Fonction anti-panique
- 04 Bei Stromausfall: Öffnung mit Schlüssel im Notfall
Primary key unlocking in case of power failure
Ouverture à clé reste prioritaire en cas de coupure de courant
- 05 2 Motoren: Entriegelung in < 1 Sek
Double engine: quick unlocking in less than 1s
Double moteur : déverrouillage rapide en moins d'1s
- 06 Steckerkontakt
Wireless power contactor
Contacteur à plots
- 07 Kabel mit Doppelfunktion Ein-/Ausgang
Double function power cable: input / output
Câble double-fonction : entrée / sortie
- 08 Trafo in Rahmen integriert
Power converter built into the door frame
Transformateur intégré au dormant
- 09 230 V-Anschluss
230 V connection
Branchement 230 V



ALUMINIUM

Leistungsstark und langlebig.

Performance and durability.

Performances et longévité.

PRODUKTPALETTE ALUMINIUM MONOBLOCK

MONOBLOC ALUMINIUM RANGE

GAMME ALUMINIUM MONOBLOC



A-124 P.14-15



A-125 P.16-17



A-138 P.18



A-139 P.19



A-140 P.19



A-141 P.20



A-108 P.21



A-132 P.22



A-128 P.23



A-142 P.24-25



A-131 P.26



A-122 P.27



A-111 P.28



A-104 P.29



A-103 P.30



A-115 P.31



A-129 P.32-33



A-107 P.34



A-117 P.34



A-114 P.35



A-110 P.36



A-106 P.37



A-105 P.38



A-127 P.39



A-119 P.40



A-123 P.41



A-130 P.42



A-120 P.43



A-112 P.44-45



A-143 P.46-47



A-109 P.48-49



A-100 P.50



A-101 P.50-51



A-102 P.52



A-144 P.53



A-121 P.54-55



A-145 P.56

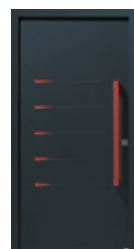

A-146 P.57



A-126 P.58-59



A-118 P.60-61

ALUMINIUM 80

ALUMINIUM 80

ALUMINIUM 80

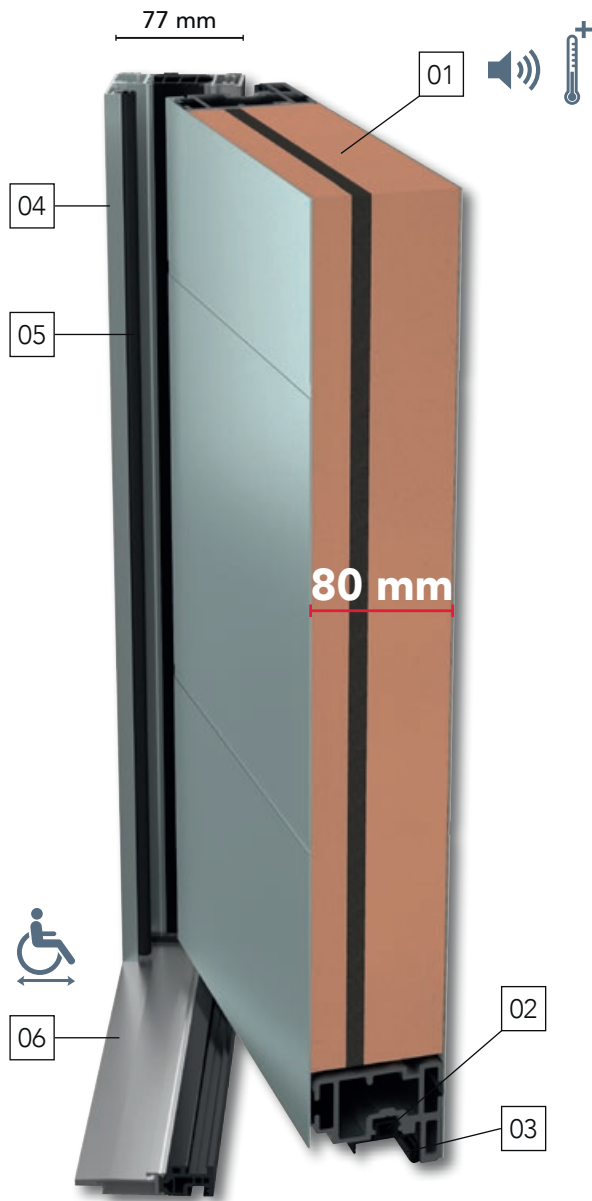

01 Türblatt in Monoblockweise, 80 mm, mit Rahmen aus stabilem Verbundmaterial. Hochleistungsfähige Wärme- und Schallisolierung. Beschläge dreidimensional verstellbar.

80 mm single panel door with high-strength composite frame. Very high thermal and acoustic insulation performance. 3 dimensional adjustable hinges.

Ouvrant monobloc de 80 mm avec cadre composite à haute résistance. Isolant thermique et acoustique à très haute performance. Fiches réglables en 3 dimensions.

02 Türblatt mit thermischer Trennung.

Thermal break door sash.

Ouvrant à rupture de pont thermique.

03 Außendichtung am Türblatt für garantierte Luftdichtigkeit.

Edge seal on the door sash ensuring airtightness.

Joint périphérique sur ouvrant assurant l'étanchéité à l'air.

04 Aluminiumrahmen mit Abdeckung für mehr Sicherheit und mit thermischer Trennung.

Aluminium wraparound door frame (reinforced security) with thermal break.

Dormant Aluminium à recouvrement (sécurité renforcée) et à rupture de pont thermique.

05 Rahmendichtung für garantierte Wasser- und Luftdichtigkeit.

Seal on door frame ensuring water and air tightness.

Joint sur dormant assurant l'étanchéité à l'eau et à l'air.

06 Aluschwelle 20 mm mit thermischer Trennung, erfüllt die Normen für Personen mit eingeschränkter Mobilität.

20 mm aluminium threshold, with thermal break, in compliance with disabled access standards.

Seuil Aluminium de 20 mm, à rupture de pont thermique, conforme aux normes pour personnes à mobilité réduite.



Standard
Standard
En standard



Motorschlossvarianten optional lieferbar
Motorized lock option available
En option serrure motorisée disponible

SCHLOSS | LOCKING SYSTEM | SERRURE



5 Punkte-Automatik
point automatic
points automatiques

2 Riegel
bolts
pênes + **2** Haken
hooks
crochets + **1** Riegel
deadbolt
pêne dormant + Riegel 1/2 Umdrehung
latch bolt
pêne 1/2 tour

WARRANTY

5
YEARS

32 Farben, darunter
colours, including
couleurs dont

17 strukturierte Farbtöne
textured shades
teintes texturées



S = Seidenmatt / Satined / Satiné
T = Feinstruktur / Textured / Texturé

GARANTIEN / WARRANTIES / GARANTIES

10 Jahre Garantie auf Rost bei allen glänzenden Farben. Standard 32 Farben, einfarbig oder 2-farbig (innen weiß RAL 9016 seidenmatt).



WARRANTY



Anti-corrosion, brightness and colour: 10 years
Exterior 32 colours as standard, both sides or bi-colour (inner side: white 9016 satined finish).

Anti-corrosion, brilliance et couleur : 10 ans
Finition 32 coloris en standard 2 faces ou bicolore (blanc 9016 satiné intérieur).

Je nach Drucktechnik kann die tatsächliche Farbe von der abgebildeten abweichen.
Die Farbe Ihrer Tür hat eine direkte Auswirkung auf die Temperatur der Oberfläche und des Zubehörs (z. B. Stoßgriff). Dunkle Farben speichern mehr Wärme, und bei direkter Sonneneinstrahlung kann die Tür sehr heiß werden, so dass Verbrennungsgefahr besteht.

The actual colour may vary due to printing limitations.
The colour of your door will affect the temperature of the surface and accessories (pull bar, etc.). Darker shades absorb heat. In direct sunlight, the door can reach high temperatures that may cause burns.

Les techniques de l'imprimerie ne permettent pas toujours de restituer très exactement la couleur réelle.
La couleur de votre porte influence directement la température de sa surface et des accessoires (barre de tirage...). Les teintes foncées absorbent la chaleur; en cas d'exposition directe au soleil, la porte peut atteindre des températures élevées pouvant provoquer des brûlures.



A-124

Ud=1,0

ALU 80

Exklusiver Stoßgriff
Exclusive pull bar
Barre de tirage exclusive



Bündige Verglasung und graue
Strukturapplikation

—
Flush glazing and textured grey decor

—
Vitrage affleurant et décor gris texturé

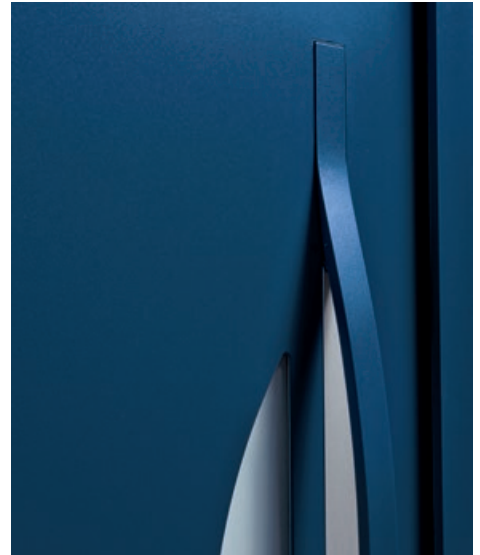



A-125

Ud=1,1

ALU 80

Exklusiver Stoßgriff
Exclusive pull bar
Barre de tirage exclusive



Integrierter Stoßgriff 2-farbig
(graues Dekor)

—
Textured grey decor on the integrated
pull bar

—
Décor gris texturé sur la barre de tirage
intégrée



A-138

Ud=1,2

ALU 80

Abbildung mit exklusivem Stoßgriff,
zweifarbig in RAL 3020 verkehrsrot
Presented with exclusive pull bar with red
powder coated decor, RAL 3020
Présenté avec une barre de tirage exclusive
avec décor laquée rouge RAL 3020



A-139

Ud=1,1

ALU 80

Abbildung mit exklusivem Stoßgriff,
zweifarbig in RAL 3020 verkehrsrot
Presented with exclusive pull bar with red
powder coated decor, RAL 3020
Présenté avec une barre de tirage exclusive
avec décor laquée rouge RAL 3020



Mit grauem Stoßgriff
erhältlich

Available with grey pull bar

Disponible avec barre de
tirage grise



A-140

Ud=1,2

ALU 80

Abbildung mit exklusivem Stoßgriff,
zweifarbig in RAL 3020 verkehrsrot
Presented with exclusive pull bar with red
powder coated decor, RAL 3020
Présenté avec une barre de tirage exclusive
avec décor laquée rouge RAL 3020



A-141

Ud=1,0

ALU 80

Abbildung mit Edelstahl Stoßgriff 950 mm
Presented with stainless steel pull bar 950 mm
Présenté avec une barre de tirage inox 950 mm



2 Materialarten übereinander
angebracht

—
Overlay of materials and colours

—
Superposition de matières et couleurs





A-108

Ud=1,1

ALU 80

Abbildung mit Edelstahl Stoßgriff 950 mm
Presented with stainless steel pull bar 950 mm
Présenté avec une barre de tirage inox 950 mm



A-132

Ud=1,1

ALU 80

Abbildung mit Edelstahl Stoßgriff 950 mm

Presented with stainless steel pull bar 950 mm

Présenté avec une barre de tirage inox 950 mm



Abbildung mit Edelstahlapplikationen
(nur außenseitig)

—
Stainless steel finish decor only on the outer side

—
Décor ton inox face extérieure uniquement



A-128

Ud=1,1

ALU 80

Abbildung mit Edelstahl Stoßgriff 1800 mm
Presented with stainless steel pull bar 1800 mm
Présenté avec une barre de tirage inox 1800 mm





A-142

Ud=1,0

ALU 80

Abbildung mit Edelstahl Stoßgriff 950 mm
Presented with stainless steel pull bar 950 mm
Présenté avec une barre de tirage inox 950 mm



Abbildung mit Edelstahlapplikationen
(nur außenseitig)

—
Stainless steel finish decor only on the outer side

—
Décor ton inox face extérieure uniquement



A-131

Ud=1,0

ALU 80

Abbildung mit Edelstahl Stoßgriff 950 mm
Presented with stainless steel pull bar 950 mm
Présenté avec une barre de tirage inox 950 mm



A-122

Ud=1,1

ALU 80

Abbildung mit Edelstahl Stoßgriff 1800 mm
Presented with stainless steel pull bar 1800 mm
Présenté avec une barre de tirage inox 1800 mm



A-111

Ud=1,1

ALU 80

Abbildung mit Edelstahl Stoßgriff 1800 mm

Presented with stainless steel pull bar 1800 mm

Présenté avec une barre de tirage inox 1800 mm



A-104

Ud=1,1

ALU 80

Abbildung mit Edelstahl Stoßgriff 950 mm
Presented with stainless steel pull bar 950 mm
Présenté avec une barre de tirage inox 950 mm



A-103

Ud=1,1

ALU 80

Abbildung mit Edelstahl Stoßgriff 1800 mm
Presented with stainless steel pull bar 1800 mm
Présenté avec une barre de tirage inox 1800 mm



A-115

Ud=1,1

ALU 80

Abbildung mit Edelstahl Stoßgriff 950 mm
Presented with stainless steel pull bar 950 mm
Présenté avec une barre de tirage inox 950 mm



Spiegeldekor beidseitig

Mirror decor on both sides

Décors miroir deux faces

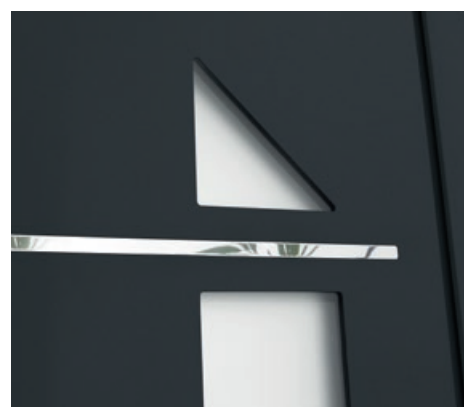



A-129

Ud=1,2

ALU 80

Exklusiver Stoßgriff
Exclusive pull bar
Barre de tirage exclusive



Stoßgriff in Verglasungsrahmen
integriert

—
Pull bar integrated into the glazing frame
—

Barre de tirage intégrée au cadre
de vitrage



A-107

Ud=1,1

ALU 80

Abbildung mit Edelstahl Stoßgriff 950 mm
Presented with stainless steel pull bar 950 mm
Présenté avec une barre de tirage inox 950 mm



A-117

Ud=1,1

ALU 80

Abbildung mit Edelstahl Stoßgriff 950 mm
Presented with stainless steel pull bar 950 mm
Présenté avec une barre de tirage inox 950 mm





A-114

Ud=1,1

ALU 80

Abbildung mit Edelstahl Stoßgriff 950 mm
Presented with stainless steel pull bar 950 mm
Présenté avec une barre de tirage inox 950 mm





A-110

Ud=1,1

ALU 80

Abbildung mit Edelstahl Stoßgriff 950 mm
Presented with stainless steel pull bar 950 mm
Présenté avec une barre de tirage inox 950 mm



A-106

Ud=1,1

ALU 80

Abbildung mit Edelstahl Stoßgriff 950 mm
Presented with stainless steel pull bar 950 mm
Présenté avec une barre de tirage inox 950 mm



A-105

Ud=1,1

ALU 80

Abbildung mit Edelstahl Stoßgriff 1800 mm
Presented with stainless steel pull bar 1800 mm
Présenté avec une barre de tirage inox 1800 mm





A-127

Ud=1,1

ALU 80

Edelstahl Stoßgriff 1300 mm
Stainless steel pull bar 1300 mm
Barre de tirage inox 1300 mm



A-119

Ud=1,1

ALU 80

Abbildung mit Edelstahl Stoßgriff 950 mm

Presented with stainless steel pull bar 950 mm

Présenté avec une barre de tirage inox 950 mm



A-123

Ud=1,1

ALU 80

Abbildung mit Edelstahl Stoßgriff 950 mm
Presented with stainless steel pull bar 950 mm
Présenté avec une barre de tirage inox 950 mm



A-130

Ud=1,1

ALU 80

Abbildung mit Edelstahl Stoßgriff 950 mm

Presented with stainless steel pull bar 950 mm

Présenté avec une barre de tirage inox 950 mm



Spiegeldekor beidseitig

—

Mirror decor on both sides

—

Décors miroir deux faces



A-120

Ud=1,6

ALU 80

Abbildung mit Edelstahl Knaufgarnitur

Presented with stainless steel pull handle

Présenté avec une poignée de tirage inox





A-112

Ud=0,93

ALU 80

Abbildung mit Edelstahl Stoßgriff 950 mm
Presented with stainless steel pull bar 950 mm
Présenté avec une barre de tirage inox 950 mm



Graues Dekor, eloxiert (nur Außenseite)

—

Grey anodized decor only on the external side

—

Décor gris anodisé uniquement face extérieure



A-143

Ud=0,93

ALU 80

Abbildung mit Edelstahl Stoßgriff 950 mm
Presented with stainless steel pull bar 950 mm
Présenté avec une barre de tirage inox 950 mm







A-109

Ud=0,93

ALU 80

Edelstahl Stoßgriff 1300 mm
Stainless steel pull bar 1300 mm
Barre de tirage inox 1300 mm



A-100

Ud=0,93

ALU 80

Abbildung mit Edelstahl Stoßgriff 950 mm
Presented with stainless steel pull bar 950 mm
Présenté avec une barre de tirage inox 950 mm



A-101

Ud=0,93

ALU 80

Abbildung mit Edelstahl Stoßgriff 1800 mm
Presented with stainless steel pull bar 1800 mm
Présenté avec une barre de tirage inox 1800 mm







A-102

Ud=0,93

ALU 80

Abbildung mit Edelstahl Stoßgriff 950 mm
Presented with stainless steel pull bar 950 mm
Présenté avec une barre de tirage inox 950 mm



A-144

Ud=0,93

ALU 80

Exklusiver Stoßgriff
Exclusive pull bar
Barre de tirage exclusive



Integrierter Stoßgriff 2-farbig (graues Dekor)

—

Textured grey decor on the integrated pull bar

—

Décor gris texturé sur la barre de tirage intégrée



A-121

Ud=0,93

ALU 80

Lackierter Stoßgriff 930 mm
Powder coated pull bar 930 mm
Barre de tirage laquée 930 mm





A-145

Ud=0,93

ALU 80

Stoßgriff lackiert 930 mm
Powder coated pull bar 930 mm
Barre de tirage laquée 930 mm



Applikationen und Stoßgriff
gleichfarbig nur anodic grau

Decor and pull bar in anodic grey finish only

Décor et barre de tirage gris anodic
uniquement

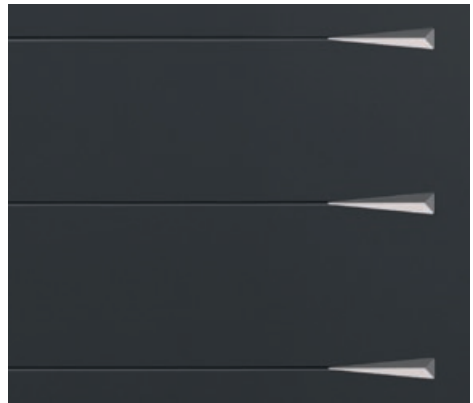

A-146

Ud=0,93

ALU 80

Stoßgriff lackiert 930 mm
Powder coated pull bar 930 mm
Barre de tirage laquée 930 mm



Applikationen und Stoßgriff
gleichfarbig nur verkehrsrot RAL 3020

Decor and pull bar in red RAL 3020 only

Décor et barre de tirage rouge RAL 3020
uniquement

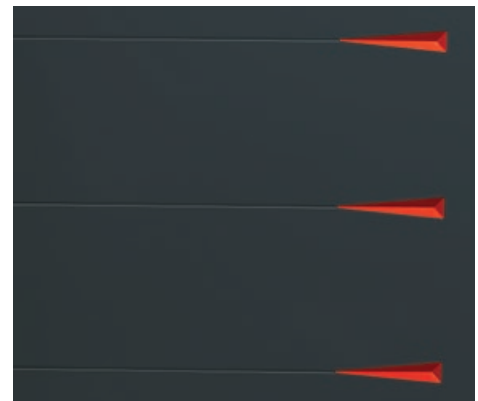



A-126

Ud=1,4

ALU 80

Abbildung mit Edelstahl Knaufgarnitur

Presented with stainless steel pull handle

Présenté avec une poignée de tirage inox



Aluminiumgussgitter in der Verglasung integriert

Cast aluminium grid inserted in the glazing

Grille en fonte d'Aluminium insérée dans le vitrage



A-118

Ud = 0,93

ALU 80

Abbildung mit Edelstahl Knaufgarnitur

Presented with stainless steel pull handle

Présenté avec une poignée de tirage inox



Elegante Abdeck - und Zierleiste mit großem Griff

Cast aluminium lock rail and elegant moulding with central pull bar

Cimaise et moulure cossues avec bâton de maréchal







ALUSTAHL

*Ausgewogenes Preis-
Leistungsverhältnis.*

ALUSTEEL

*The best performance/
price ratio.*

ACIER

*Le meilleur rapport
performance/prix.*

PRODUKTPALETTE ALUSTAHL MONOBLOCK

MONOBLOC ALUSTEEL RANGE

GAMME ACIER MONOBLOC



S-112 P.66-67



S-118 P.68



S-113 P.69



S-120 P.70



S-110 P.71



S-114 P.71



S-115 P.72



S-121 P.73



S-119 P.74-75



S-133 P.76



S-134 P.77



S-135 P.78



S-117 P.79



S-116 P.80-81



S-111 P.82



S-109 P.83



S-106 P.84-85



S-132 P.86-87



S-131 P.88



S-128 P.89



S-129 P.90



S-130 P.91



S-104 P.92-93



S-102 P.94



S-103 P.95



S-100 P.96



S-101 P.97



S-105 P.98



S-108 P.99

Modelle erhältlich in 48 und 68+

Models available in 48 and 68+ design

Modèles disponibles en conception 48 et 68+

ALUSTAHL

ALUSTEEL

ACIER

BAUTIEFE FLÜGEL | CORNER | ANGLE 48 mm

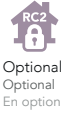

BAUTIEFE FLÜGEL | CORNER | ANGLE 68 mm

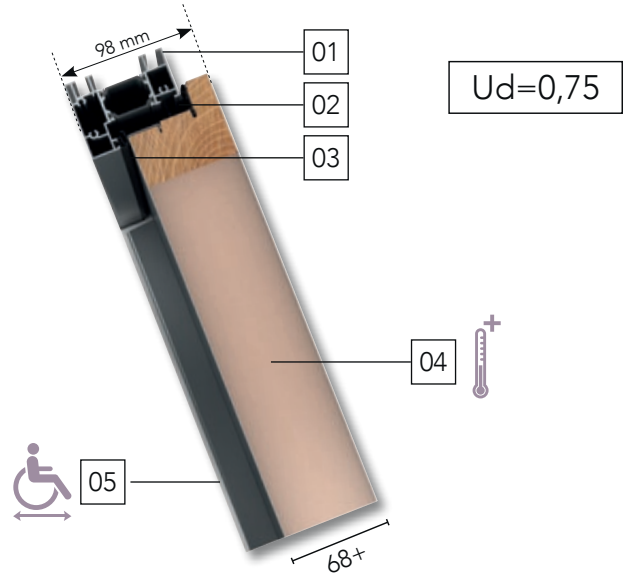
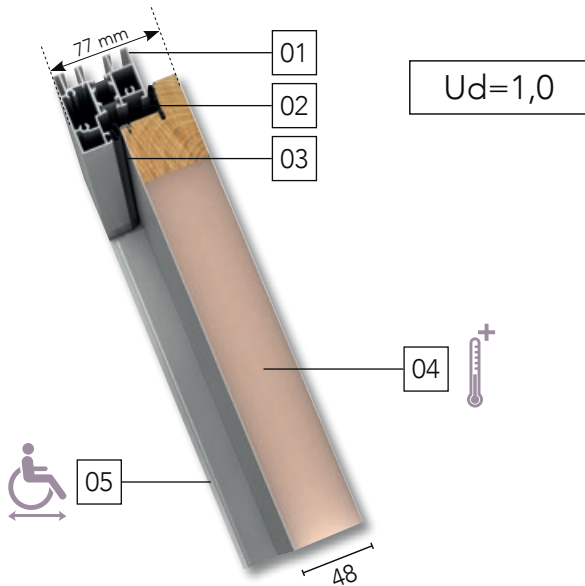

- 01** Rahmen aus Aluminium mit thermischer Trennung.
Aluminium frame with thermal break.
Dormant aluminium à rupture de pont thermique.
- 02** Außendichtung am Türblatt gewährleistet Luftdichtigkeit.
Edge seal on door sash for airtightness.
Joint périphérique sur ouvrant pour étanchéité à l'air.
- 03** Dichtung am Rahmen gewährleistet Wasserdichtigkeit.
Seal on door frame for watertightness.
Joint sur dormant pour étanchéité à l'eau.

- 04** Türblatt aus 2 im Postforming-Verfahren hergestellten Deckschalen aus Stahl mit innenliegender Wärmedämmung aus Polyurethanschaum.
Door composed of 2 postformed steel facings, separated by thermal insulation (polyurethane foam).
Ouvrant composé de 2 parements Acier postformés, séparés par un isolant thermique (mousse polyuréthane).
- 05** Aluminium-Schwelle 20 mm entspricht den Normen für „Personen mit eingeschränkter Mobilität“ Schwelle mit thermischer Trennung für Stahl 68+.
20 mm aluminium threshold in compliance with disabled access standards. Thermal break threshold for the Alusteel 68+.
Seuil Aluminium de 20 mm conforme aux normes pour «personnes à mobilité réduite». Seuil à rupture de pont thermique pour l'Acier 68+.

ORNAMENTRAHMEN PVC /
PVC GLAZING BEADS / PARCLOSES PVC



ORNAMENTRAHMEN ALUMINIUM /
ALUMINIUM GLAZING BEADS / PARCLOSES ALUMINIUM



FARBEN | COLOURS | COULEURS

Standardmäßig RAL 9106 (weiß), und RAL 7016 (anthrazit) beidseitig.
Either white 9016 or grey 7016 satin-finish on both sides as standard.
Blanc 9016 et gris 7016 satiné 2 faces en standard.

Standardmäßig 18 Farben einfarbig.
18 colours, single colour as standard.
18 couleurs, monocoloration en standard.

SCHLOSS | LOCKING SYSTEM | SERRURE



5 Punkte-Automatik
point automatic
points automatiques

2 Riegel
bolts
pênes + **2** Haken
hooks
crochets + **1** Riegel
deadbolt
pêne dormant + Riegel 1/2 Umdrehung
latch bolt
pêne 1/2 tour

WARRANTY

5
YEARS

18 Farben, darunter colours, including couleurs dont
6 strukturierte Farbtöne textured shades teintes texturées



S = Seidenmatt / Satined / Satiné
 T = Feinstruktur / Textured / Texturé

GARANTIE / WARRANTIES / GARANTIES

KORROSION
 CORROSION



Türen mit Qualisteelcoat-Label seit 2012
 Doors qualisteelcoat certified since 2012
 Portes labellisées qualisteelcoat depuis 2012

* 3 Jahre außer Standardfarben
 * 3 years for non-standard colours
 * 3 ans hors nuancier standard

FARBEN UND GLANZ*
 SHINE AND COLOURS*



WHITE 9016 S



11 SATINED
 COLOURS



6 TEXTURED
 COLOURS

Je nach Drucktechnik kann die tatsächliche Farbe von der abgebildeten abweichen.
 Die Farbe Ihrer Tür hat eine direkte Auswirkung auf die Temperatur der Oberfläche und des Zubehörs (z. B. Stoßgriff). Dunkle Farben speichern mehr Wärme, und bei direkter Sonneneinstrahlung kann die Tür sehr heiß werden, so dass Verbrennungsgefahr besteht.

The actual colour may vary due to printing limitations.
 The colour of your door will affect the temperature of the surface and accessories (pull bar, etc.). Darker shades absorb heat. In direct sunlight, the door can reach high temperatures that may cause burns.

Les techniques de l'imprimerie ne permettent pas toujours de restituer très exactement la couleur réelle.
 La couleur de votre porte influence directement la température de sa surface et des accessoires (barre de tirage...). Les teintes foncées absorbent la chaleur; en cas d'exposition directe au soleil, la porte peut atteindre des températures élevées pouvant provoquer des brûlures.

S-112 AluStahl 48
Alusteel 48
Acier 48

Ud=1,4

Abbildung mit Edelstahl Stoßgriff 950 mm
Presented with stainless steel pull bar 950 mm
Présenté avec une barre de tirage inox 950 mm

S-112+ AluStahl 68
Alusteel 68
Acier 68

Ud=1,1



Ornamentrahmen PVC, AluStahl 48

—
PVC glazing beads, Alusteel 48

—
Parcloses PVC, Acier 48



Ornamentrahmen Aluminium,
AluStahl 68 mm

—
Aluminium glazing beads, Alusteel 68 +

—
Parcloses Aluminium, Acier 68+

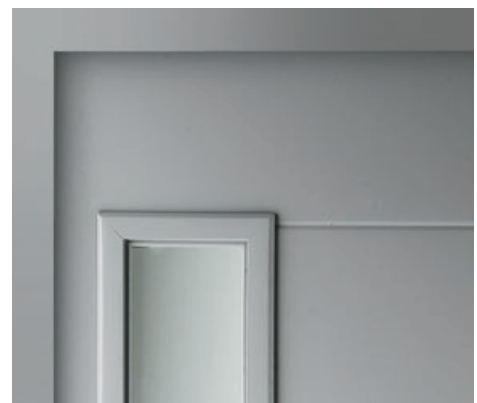



S-118 AluStahl 48
Alusteel 48
Acier 48

Ud=1,4

Abbildung mit Edelstahl Stoßgriff 400 mm
Presented with stainless steel pull bar 400 mm
Présenté avec une barre de tirage inox 400 mm



S-118+ AluStahl 68
Alusteel 68
Acier 68

Ud=1,1

Feines 3D-Dekor

—
Delicate 3D decor

—
Décors 3D tout en finesse

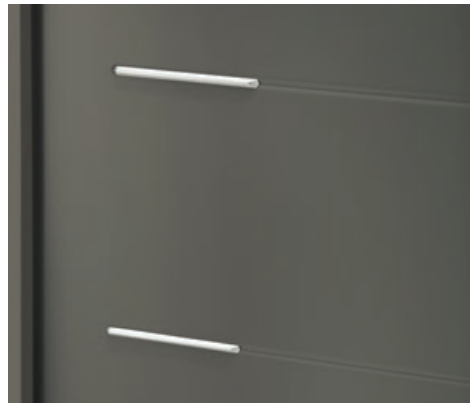

S-113 AluStahl 48

Alusteel 48
Acier 48

Ud=1,4

Abbildung mit Edelstahl Stoßgriff 400 mm
Presented with stainless steel pull bar 400 mm
Présenté avec une barre de tirage inox 400 mm

S-113+ AluStahl 68

Alusteel 68
Acier 68

Ud=1,1





S-120 AluStahl 48
Alusteel 48
Acier 48

Ud=1,2

S-120+ AluStahl 68
Alusteel 68
Acier 68

Ud=0,91

Abbildung mit Edelstahl Stoßgriff 950 mm
Presented with stainless steel pull bar 950 mm
Présenté avec une barre de tirage inox 950 mm



S-110 **AluStahl 48** Alusteel 48 Acier 48

Ud=1,4

S-110+ **AluStahl 68** Alusteel 68 Acier 68

Ud=1,0

Abbildung mit Edelstahl Stoßgriff 400 mm
Presented with stainless steel pull bar 400 mm
Présenté avec une barre de tirage inox 400 mm



S-114 **AluStahl 48** Alusteel 48 Acier 48

Ud=1,4

S-114+ **AluStahl 68** Alusteel 68 Acier 68

Ud=1,1

Abbildung mit Edelstahl Stoßgriff 400 mm
Presented with stainless steel pull bar 400 mm
Présenté avec une barre de tirage inox 400 mm



S-115 AluStahl 48
Alusteel 48
Acier 48

Ud=1,5

Abbildung mit Edelstahl Stoßgriff 400 mm
Presented with stainless steel pull bar 400 mm
Présenté avec une barre de tirage inox 400 mm

S-115+ AluStahl 68
Alusteel 68
Acier 68

Ud=1,2



S-121 AluStahl 48
Alusteel 48
Acier 48

Ud=1,2

Abbildung mit Edelstahl Stoßgriff 950 mm
Presented with stainless steel pull bar 950 mm
Présenté avec une barre de tirage inox 950 mm

S-121+ AluStahl 68
Alusteel 68
Acier 68

Ud=0,85



S-119 AluStahl 48
Alusteel 48
Acier 48

Ud=1,3

Abbildung mit Edelstahl Stoßgriff 400 mm
Presented with stainless steel pull bar 400 mm
Présenté avec une barre de tirage inox 400 mm

S-119+ AluStahl 68
Alusteel 68
Acier 68

Ud=1,1





S-133 AluStahl 48
Alusteel 48
Acier 48

Ud=1,3

Abbildung mit Edelstahl Stoßgriff 400 mm
Presented with stainless steel pull bar 400 mm
Présenté avec une barre de tirage inox 400 mm

S-133+ AluStahl 68
Alusteel 68
Acier 68

Ud=1,1



S-134 AluStahl 48
Alusteel 48
Acier 48

Ud=1,3

Abbildung mit Edelstahl Stoßgriff 400 mm
Presented with stainless steel pull bar 400 mm
Présenté avec une barre de tirage inox 400 mm



S-134+ AluStahl 68
Alusteel 68
Acier 68

Ud=1,0

Bläschen Reliefmotiv

—
Raised bubble design

—
Motifs bulles en relief



S-135 AluStahl 48
Alusteel 48
Acier 48

Ud=1,3

Abbildung mit Edelstahl Stoßgriff 400 mm
Presented with stainless steel pull bar 400 mm
Présenté avec une barre de tirage inox 400 mm



S-135+ AluStahl 68
Alusteel 68
Acier 68

Ud=1,1

Bündige Verglasung und neuartiges
Reliefmotiv

—
Flush glazing and unique raised design
—

Vitrage affleurant et relief inédit

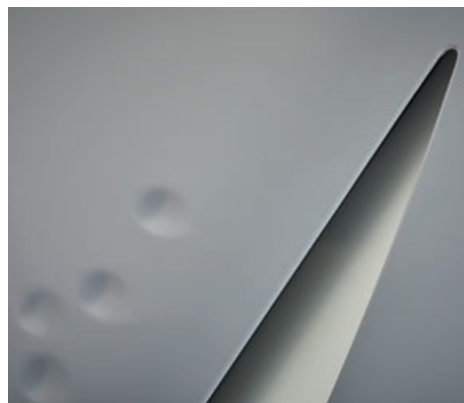

S-117 AluStahl 48
Alusteel 48
Acier 48

Ud=1,8

Abbildung mit Edelstahl Stoßgriff 950 mm
Presented with stainless steel pull bar 950 mm
Présenté avec une barre de tirage inox 950 mm

S-117+ AluStahl 68
Alusteel 68
Acier 68

Ud=1,3





S-116 AluStahl 48
Alusteel 48
Acier 48

Ud=1,8

Abbildung mit Edelstahl Stoßgriff 400 mm
Presented with stainless steel pull bar 400 mm
Présenté avec une barre de tirage inox 400 mm

S-116+ AluStahl 68
Alusteel 68
Acier 68

Ud=1,3



S-111 AluStahl 48
Alusteel 48
Acier 48

Ud=1,1

Abbildung mit Edelstahl Stoßgriff 400 mm
Presented with stainless steel pull bar 400 mm
Présenté avec une barre de tirage inox 400 mm

S-111+ AluStahl 68
Alusteel 68
Acier 68

Ud=0,82



S-109 AluStahl 48
Alusteel 48
Acier 48

Ud=1,1

Abbildung mit Edelstahl Stoßgriff 400 mm
Presented with stainless steel pull bar 400 mm
Présenté avec une barre de tirage inox 400 mm

S-109+ AluStahl 68
Alusteel 68
Acier 68

Ud=0,82



S-106 AluStahl 48
Alusteel 48
Acier 48

Ud=1,0

Abbildung mit Edelstahl Stoßgriff 400 mm
Presented with stainless steel pull bar 400 mm
Présenté avec une barre de tirage inox 400 mm



S-106+ AluStahl 68
Alusteel 68
Acier 68

Ud=0,75

Edle 3-D Applikation

—
Delicate 3D decor

—
Décors 3D tout en finesse

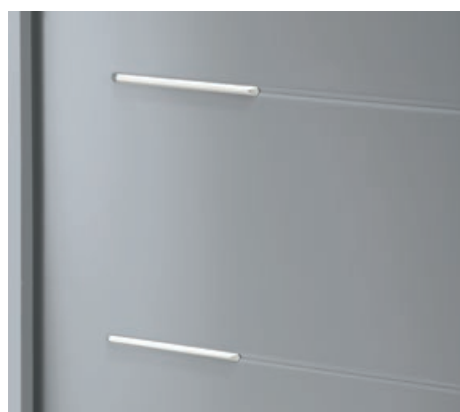





S-132 AluStahl 48
Alusteel 48
Acier 48

Ud=1,0

Abbildung mit Edelstahl Stoßgriff 950 mm
Presented with stainless steel pull bar 950 mm
Présenté avec une barre de tirage inox 950 mm

S-132+ AluStahl 68
Alusteel 68
Acier 68

Ud=0,75



S-131 AluStahl 48
Alusteel 48
Acier 48

Ud=1,0

Abbildung mit Edelstahl Stoßgriff 950 mm
Presented with stainless steel pull bar 950 mm
Présenté avec une barre de tirage inox 950 mm

S-131+ AluStahl 68
Alusteel 68
Acier 68

Ud=0,75



S-128 AluStahl 48
Alusteel 48
Acier 48

Ud=1,0

Abbildung mit Edelstahl Stoßgriff 400 mm
Presented with stainless steel pull bar 400 mm
Présenté avec une barre de tirage inox 400 mm

S-128+ AluStahl 68
Alusteel 68
Acier 68

Ud=0,75





S-129 AluStahl 48

Alusteel 48
Acier 48

Ud=1,0

S-129+ AluStahl 68

Alusteel 68
Acier 68

Ud=0,75

Abbildung mit Edelstahl Stoßgriff 400 mm
Presented with stainless steel pull bar 400 mm
Présenté avec une barre de tirage inox 400 mm



Bläschen Reliefmotiv

—
Raised bubble design

—
Motifs bulles et en relief

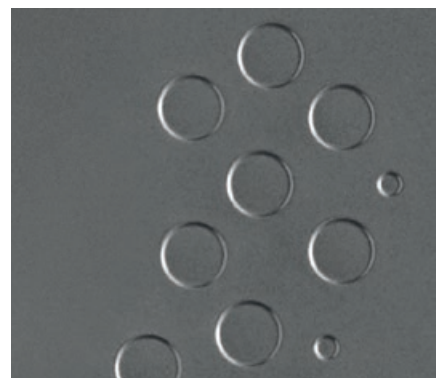

S-130

AluStahl 48
Alusteel 48
Acier 48

Ud=1,0

Abbildung mit Edelstahl Stoßgriff 400 mm
Presented with stainless steel pull bar 400 mm
Présenté avec une barre de tirage inox 400 mm



S-130+

AluStahl 68
Alusteel 68
Acier 68

Ud=0,75

Geprägtes Reliefmotiv

Subtle raised design

Motifs subtils en relief

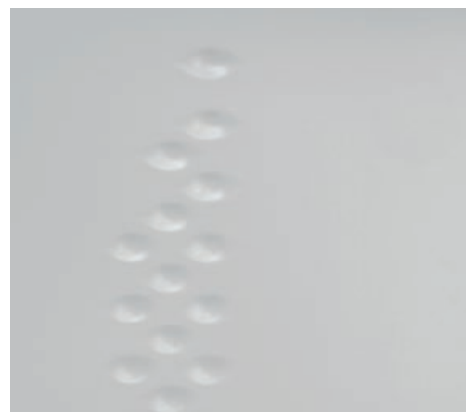

S-104 AluStahl 48
Alusteel 48
Acier 48

Ud=1,0

Abbildung mit Edelstahl Stoßgriff 400 mm
Presented with stainless steel pull bar 400 mm
Présenté avec une barre de tirage inox 400 mm

S-104+ AluStahl 68
Alusteel 68
Acier 68

Ud=0,75





S-102 AluStahl 48
Alusteel 48
Acier 48

Ud=1,0

Abbildung mit Edelstahl Stoßgriff 950 mm
Presented with stainless steel pull bar 950 mm
Présenté avec une barre de tirage inox 950 mm

S-102+ AluStahl 68
Alusteel 68
Acier 68

Ud=0,75



S-103

AluStahl 48
Alusteel 48
Acier 48

Ud=1,0

Abbildung mit Edelstahl Stoßgriff 950 mm
Presented with stainless steel pull bar 950 mm
Présenté avec une barre de tirage inox 950 mm

S-103+

AluStahl 68
Alusteel 68
Acier 68

Ud=0,75



S-100 AluStahl 48
Alusteel 48
Acier 48

Ud=1,0

Abbildung mit Edelstahl Stoßgriff 400 mm
Presented with stainless steel pull bar 400 mm
Présenté avec une barre de tirage inox 400 mm

S-100+ AluStahl 68
Alusteel 68
Acier 68

Ud=0,75



S-101

AluStahl 48
Alusteel 48
Acier 48

Ud=1,0

Abbildung mit Edelstahl
Knaufgarnitur, optional RC2
Presented with stainless steel
pull handle, optional RC2
Présenté avec une poignée
de tirage inox, RC2 en option

S-101+

AluStahl 68
Alusteel 68
Acier 68

Ud=0,75



S-105 AluStahl 48
Alusteel 48
Acier 48

Ud=1,2

Abbildung mit Edelstahl Knaufgarnitur
Presented with stainless steel pull handle
Présenté avec une poignée de tirage inox

S-105+ AluStahl 68
Alusteel 68
Acier 68

Ud=0,84



S-108 AluStahl 48
Alusteel 48
Acier 48

Ud=1,3

Abbildung mit Edelstahl Stoßgriff 400 mm
Presented with stainless steel pull bar 400 mm
Présenté avec une barre de tirage inox 400 mm

S-108+ AluStahl 68
Alusteel 68
Acier 68

Ud=1,2





HOLZ

Leistungsfähig, edel und warm.

TIMBER

*Performance, nobility
and warmth of wood.*

BOIS

*Performance, noblesse
et chaleur du bois.*

PRODUKTPALETTE HOLZ MONOBLOCK

MONOBLOC TIMBER RANGE

GAMME BOIS MONOBLOC



T-203 P.104-105



T-202 P.106-107



T-201 P.108



T-105 P.109

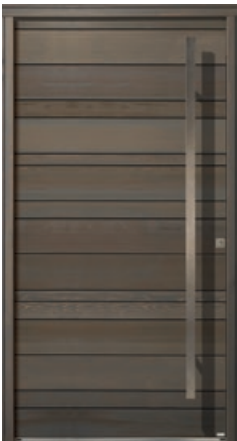

T-103 P.110-111



T-102 P.112

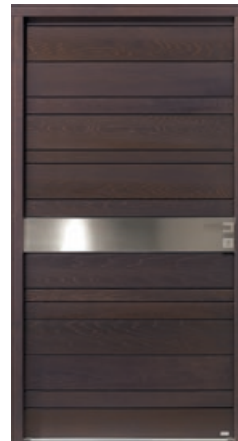

T-108 P.113



T-101 P.114

HOLZ TIMBER BOIS

TÜREN AUS ROTER ZEDER / RED CEDAR DOORS / PORTES EN RED CEDAR (T-101, T-102, T-103, T-108, T-201, T-202)

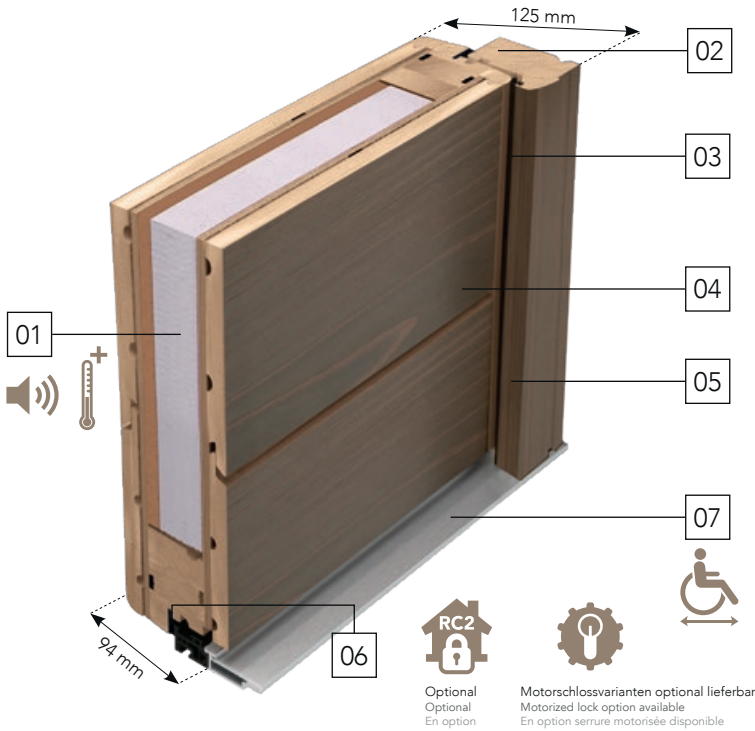

- 01** Türblatt in Monoblockweise, 94 mm.
Hochleistungsfähige Wärme- und Schallsisolierung.
94 mm single panel door. Very high performance thermal and acoustic insulation.
Ouvrant monobloc de 94 mm. Isolant thermique et acoustique à très haute performance.
- 02** Rahmeninnenseite in massive Eiche.
Frame: solid oak inner side.
Dormant chêne massif face intérieure.
- 03** Äußere Rahmendichtung.
Edge seal on the frame.
Joint périphérique sur dormant.
- 04** Beplankt mit Nut- und Federbrettern in massiver roter Zeder.
Wooden strips in Solid Red Cedar.
Lames de bois en Red Cedar Massif.
- 05** Rahmenseite in massiver Roter Zeder.*
Frame: Red Cedar outer side.*
Dormant Red Cedar face extérieure.*
- 06** Außendichtung am Türblatt.
Edge seal on the door sash.
Joint périphérique sur ouvrant.
- 07** Aluschwelle 20 mm mit thermischer Trennung, erfüllt die Normen für Personen mit eingeschränkter Mobilität.
20 mm aluminium threshold, with thermal break, in compliance with disabled access standards.
Seuil Aluminium de 20 mm, à rupture de pont thermique, conforme aux normes pour personnes à mobilité réduite.

* Modelle T-101, 102, 103, 108: Rahmen außen massive rote Zeder, innen massive Eiche
 * T-101, 102, 103, 108 models: Frame outer in Red Cedar and inner in Solid oak
 * Modèles T-101, 102, 103, 108 : Dormant en Red Cedar face extérieure et en chêne massif face intérieure
 * Modelle T-201, 202: Rahmen außen Aluminium, innen massive Eiche
 * T-201, 202 models: Frame outer in Aluminum and inner in Solid oak
 * Modèles T-201, 202 : Dormant en aluminium face extérieure et en chêne massif face intérieure

FARBEN / COLOURS / COULEURS

4 Ausführungen Außen- und Innenseite
Exterior and interior finishes
Finitions extérieure et intérieure

1 Ausführung Innenseite
Interior finish
Finition intérieure

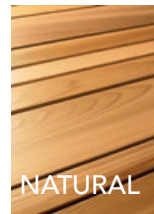
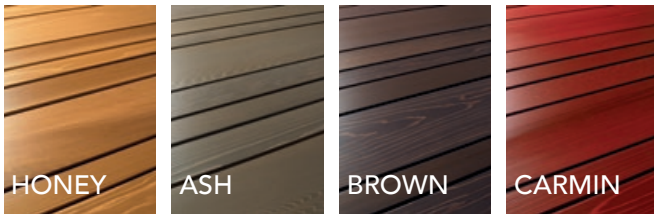

GARANTIE / WARRANTY / GARANTIE

WARRANTY



Glanz und Farbe
Brightness and colour
Brillance et couleur

SCHLOSS / LOCKING SYSTEM / SERRURE

WARRANTY



5-Punkt-Schloss
5 point lock
Serrure 5 points

TÜREN AUS MASSIVER EICHE / SOLID OAK DOORS / PORTES EN CHÊNE MASSIF (T-105, T-203)

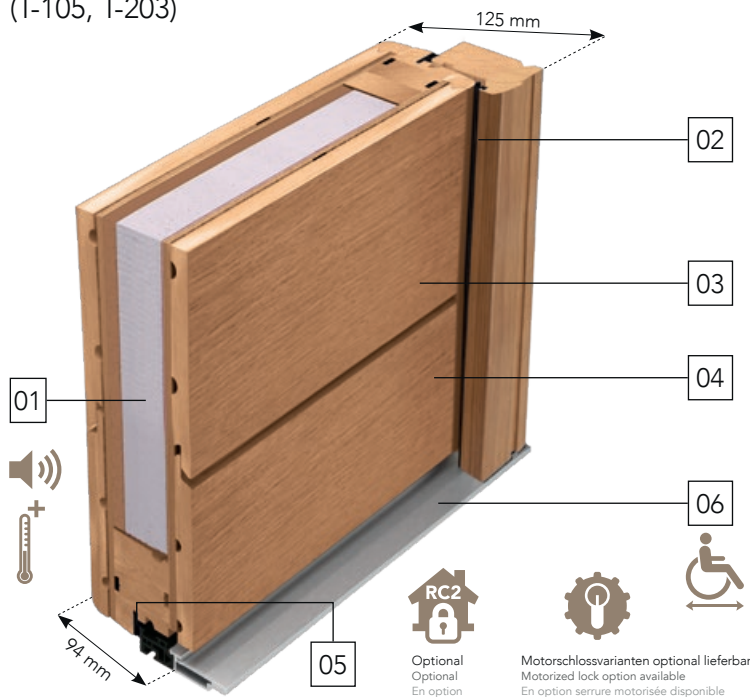

- 01 Türblatt in Monoblockweise, 94 mm. Hochleistungsfähige Wärme- und Schallsisolierung. 94 mm single panel door. Very high performance thermal and acoustic insulation. Ouvrant monobloc de 94 mm. Isolant thermique et acoustique à très haute performance.
- 02 Äußere Rahmendichtung. Edge seal on the frame. Joint périphérique sur dormant.
- 03 Beplankt mit Nut-und Federbrettern in Massiver. Wooden strips in Solid Oak. Lames de bois en Chêne Massif.
- 04 Rahmenaußenseite in massiver Eiche.* Solid oak frame.* Dormant en Chêne Massif.*
- 05 Außendichtung am Türblatt. Edge seal on the door sash. Joint périphérique sur ouvrant.
- 06 Aluschwelle 20 mm mit thermischer Trennung, erfüllt die Normen für Personen mit eingeschränkter Mobilität. 20 mm aluminium threshold, with thermal break, in compliance with disabled access standards. Seuil Aluminium de 20 mm, à rupture de pont thermique, conforme aux normes pour personnes à mobilité réduite.

* Modell T-105: Rahmen innen und außen in massiver Eiche
 * T-105 Model: Solid oak frame on both sides
 * Modèle T-105 : Dormant en chêne massif 2 faces
 * Modell T-203: Rahmen außen Aluminium, innen massiver Eiche
 * T-203 Model: Frame outer in Aluminum and inner in Solid oak
 * Modèle T-203 : Dormant en aluminium face extérieure et en chêne massif face intérieure

FARBEN / COLOURS / COULEURS

4 Ausführungen Außen- und Innenseite
 exterior and interior finishes
 finitions extérieure et intérieure

1 Ausführung Innenseite
 interior finish
 finition intérieure



* Außer dunkle Farbtöne (RAL 8022, 9004, 9005, 9011, 9017) und Metallic-Farben (kontaktieren Sie uns)
 * Except dark colours (RAL 8022, 9004, 9005, 9011, 9017) and metallic colours (please contact us)
 * Hors teintes foncées (RAL 8022, 9004, 9005, 9011, 9017) et métallisées (nous consulter)

GARANTIE / WARRANTY / GARANTIE

WARRANTY

2 YEARS

Glanz und Farbe*
 Brightness and colour*
 Brilliance et couleur*

* Außer Auswahlmöglichkeit unter mehreren Farben (RAL): 3 Jahre / except optional choice of colours (RAL): 3 years / sauf option choix de couleur (RAL) : 3 ans

SCHLOSS / LOCKING SYSTEM / SERRURE

WARRANTY

5 YEARS

T-105
 5-Punkt-Schloss
 5 point lock
 Serrure 5 points

T-203
 7-Punkt-Schloss
 7 point lock
 Serrure 7 points

Je nach Drucktechnik kann die tatsächliche Farbe von der abgebildeten abweichen. Die Farbe Ihrer Tür hat eine direkte Auswirkung auf die Temperatur der Oberfläche und des Zubehörs (z. B. Stoßgriff). Dunkle Farben speichern mehr Wärme, und bei direkter Sonneneinstrahlung kann die Tür sehr heiß werden, so dass Verbrennungsgefahr besteht.

The actual colour may vary due to printing limitations. The colour of your door will affect the temperature of the surface and accessories (pull bar, etc.). Darker shades absorb heat. In direct sunlight, the door can reach high temperatures that may cause burns.

Les techniques de l'imprimerie ne permettent pas toujours de restituer très exactement la couleur réelle. La couleur de votre porte influence directement la température de sa surface et des accessoires (barre de tirage...). Les teintes foncées absorbent la chaleur; en cas d'exposition directe au soleil, la porte peut atteindre des températures élevées pouvant provoquer des brûlures.



T-203 Holz Timber Bois

Ud=0,83

Stoßgriff 930 mm, Lackierung in Rahmenfarbe
930 mm pull bar, powder coated in the same colour as the frame
Barre de tirage 930 mm laquée à la couleur du dormant



Nut-und Federbretter in massiver
Eiche aus Frankreich

—
Panels made from solid oak of French origin

—
Lames en chêne massif d'origine Française



T-202 Holz Timber Bois

Ud=0,81

Türdrücker in Stoßgriffleiste komplett integriert

Aluminium strip with EKYZ system, powder coated in the same colour as the frame
Bandeau aluminium avec système EKYZ
laqué à la couleur du dormant



Stoßgriffapplikationen mit EKYZ System in Rahmenfarbe lackiert

—
EKYZ system
Handle integrated in the pull bar
—

Système EKYZ
Poignée intégrée à la barre de tirage





T-201 Holz Timber Bois

Ud=0,81

Stoßgriff mit Lackierung
in Rahmenfarbe
930 mm pull bar, powder coated
in the same colour as the frame
Barre de tirage 930 mm laquée
à la couleur du dormant



T-105 Holz Timber Bois

Ud=0,80

Edelstahl Stoßgriff 1800 mm
Stainless steel pull bar 1800 mm
Barre de tirage inox 1800 mm



Nut-und Federbretter in massiver
Eiche aus Frankreich

—
Panels made from solid oak of French origin

—
Lames en chêne massif d'origine Française



T-103 Holz Timber Bois

Ud=0,76

Edelstahl Stoßgriff 1800 mm
Stainless steel pull bar 1800 mm
Barre de tirage inox 1800 mm



Edelstahl Stoßgriff passend zur
Beplankung mit roter Zeder-Holz

—
Stainless steel pull bar paired with Red
Cedar wood panels

—
Barre de tirage inox associée aux lames
de bois en Red Cedar





T-102 Holz Timber Bois

Ud=0,76

Stoßgriffleiste horizontal mit
Eingriff in integrierter, gebürsteter
Edelstahlbeplankung

Pull handle on exclusive brushed stainless
steel strip

Poignée de tirage sur bandeau inox brossé
exclusif





T-108 Holz Timber Bois

Ud=0,76

Edelstahl Drückergarnitur in integrierter,
gebürsteter Edelstahlbeplankung
Stainless steel door handle on rosette on
exclusive brushed stainless steel strip
Poignée rosace inox sur bandeau inox
brossé exclusif



Gebürstete Edelstahlbeplankung über
die gesamte Türbreite in Verbindung
mit Drückergarnitur

Brushed stainless steel panel across
the entire width of the door combined
with a door handle on rosette

Lame inox brossé sur toute la largeur
de la porte associée à une poignée rosace



T-101 Holz Timber Bois

Ud=0,76

Drückergarnitur Edelstahl
Stainless steel door handle on rosette
Poignée rosace inox



Moderne Linienführung mit
besonderer Eleganz durch gebürstetes
roter Zeder Holz

—
Contemporary lines enhanced by brushed
Red Cedar

—
Des lignes contemporaines sublimes
par le Red Cedar brossé

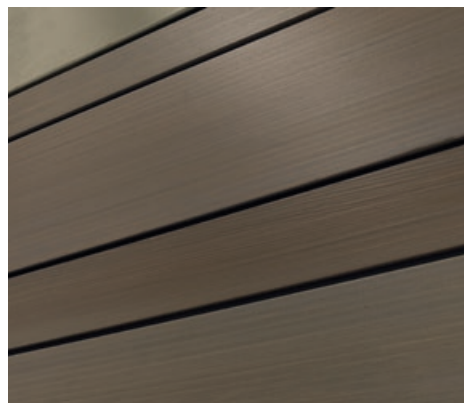



ZUBEHÖR & OPTIONEN
ACCESSORIES & OPTIONS
ACCESSOIRES & OPTIONS

LEUCHTEN & VORDÄCHER LEUCHTEND

LIGHTS AND ILLUMINATED CANOPIES

LUMINAIRES ET MARQUISES ÉCLAIRANTES

Türen und Leuchten – Die Kunst der Farbharmonie.

Doors and lights: the art of colour coordination.

Portes et lumières : l'art de la coordination des couleurs.

33 Farben
Colours
Couleurs

8 Leuchten Roger Pradier
Roger Pradier lights
luminaires Roger Pradier

TRENDMODELLE / CONTEMPORARY LIGHTS / LES CONTEMPORAINS



▲ HUGY



▲ BRICK



▲ BRICK LIGNES



▲ SHERLOCK

UNSERE KLASSIKER / CLASSIC LIGHTS / LES CLASSIQUES



▲ LOUIS PHILIPPE 7



▲ PLACE DES VOSGES
1 ÉVOLUTION



▲ BELCOUR



▲ LAMPIOK



▲ ZENITH 1300 mm lacquered, in 7016 satin grey.

■ BELEUCHTUNG / LIGHTING / ECLAIRAGE

- IP 65*: Elektroschutz / Electrical protection / Protection électrique
- 1440 lumen: Leuchtplatte / Luminous screen / Dalle lumineuse
- Progressive Beleuchtung / Progressive lighting / Eclairage lumineux progressif 
- 220V: Stromanschluss über wasserdichten Stecker / Electrical connection with sealed connector / Branchement électrique par connecteur étanche

■ MONTAGE / FITTING / POSE

Einfach und schnell; Tür und Vordach können am selben Tag montiert werden / Quick and easy; the door and the canopy can be fitted in one day / Simple et rapide; possibilité de poser porte et marquise dans la même journée

* Die Schutzarten (IP) sind durch die französische Norm NF EN 60-259 definiert.
 * The protection classes (IP) are defined by NF EN 60-259 French standard.
 * Les degrés de protection (IP) sont définis par la norme française NF EN 60-259.

■ GARANTIEN / WARRANTIES / GARANTIES



ELEKTRISCHE BAUTEILE
ELECTRICAL COMPONENTS
COMPOSANTS ÉLECTRIQUES

GLANZ UND FARBE
BRIGHTNESS AND COLOUR
BRILLANCE ET COULEUR

ÄSTHETIK AESTHETICS ESTHÉTIQUE

▼ ZENITH 900 1172 x 667 mm



▼ ZENITH 1300 1572 x 667 mm



▼ ZENITH 1800 2072 x 667 mm



■ FARBEN / COLOURS / COULEURS

WHITE 9016 S	GREY 7035 S	GREY 7047 S	GREY 9006 S	GREY 7004 S
GREY 7030 S	GREY 9007 S	GREY 7039 S	GREY DB703 S	GREY 7016 S
BLUE 5003 S	BLUE 5025 S	GREEN 6005 S	GREEN 6013 S	RED 3013 S
BROWN 8019 S	WHITE 9016 T	GREY 9006 T	GREY 2400 T	GREY 9007 T
PEARL GREY 2800 T	BRONZE T	GREY 2900 T	GREY DB703 T	GREY 7016 T
BLUE 2700 T	GREEN T	GREEN 6005 T	RED 3004 T	RUSSET T
BROWN 2650 T	BLACK 2100 T	BLACK 9005 T	S = Seidenmatt / Satined / Satiné T = Feinstruktur / Textured / Texturé	

GARNITUREN

HARDWARE

LA QUINCAILLERIE

■ GRIFFE UND STOßGRIFF HANDLES AND PULLBARS POIGNÉES ET BARRES DE TIRAGE

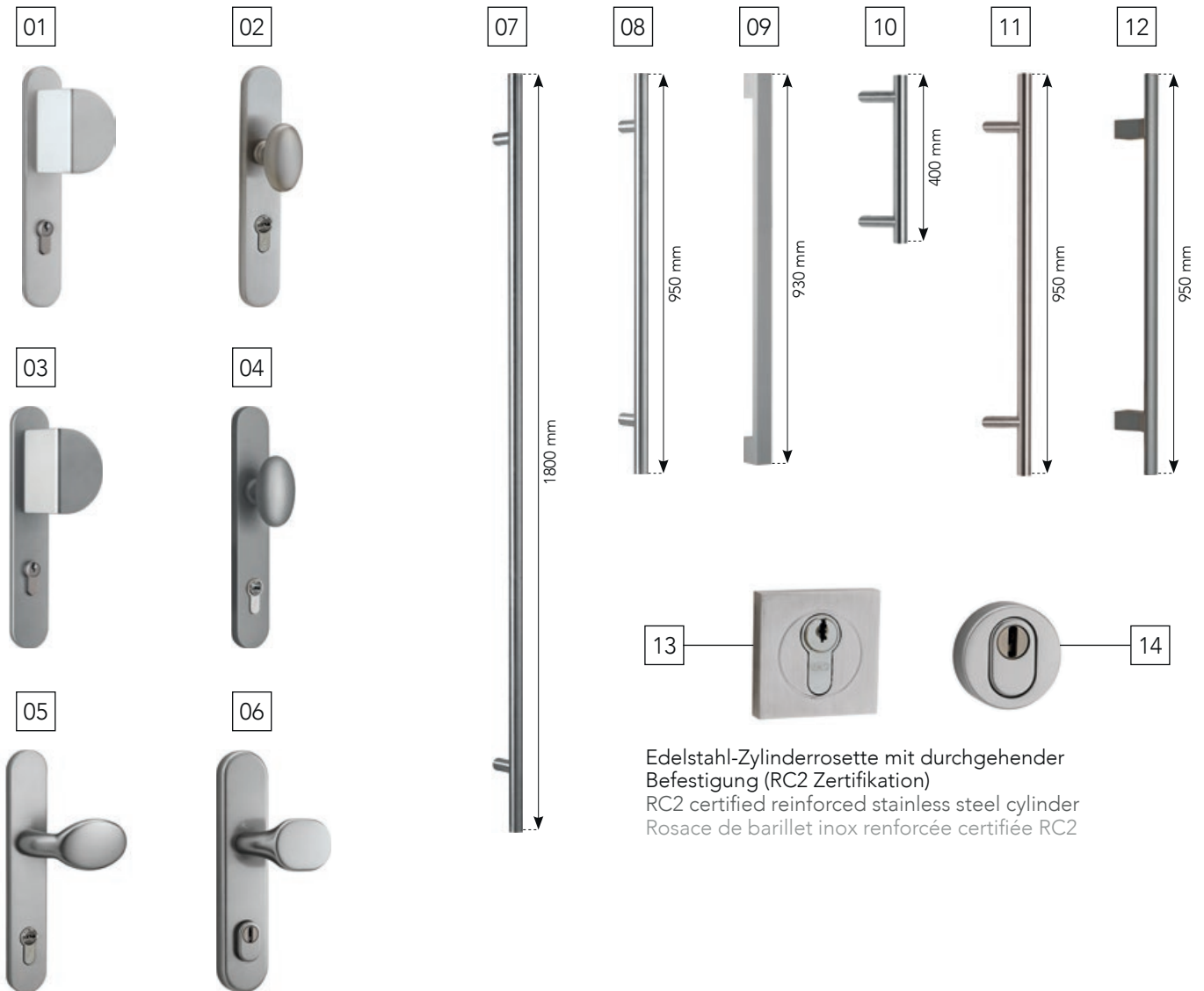

■ DRÜCKERGARNITUR MIT RUNDROSETTE INTERNAL HANDLE WITH ROSETTE POIGNÉES ROSACE INTÉRIEUR



■ TÜRDRÜCKER AUF LANGSCHILD HANDLE ON BASE PLATE POIGNÉES SUR PLAQUE

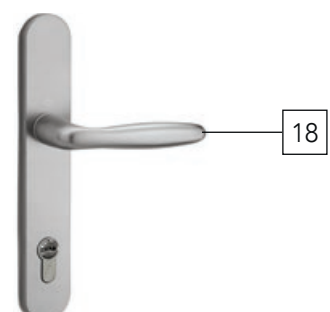

■ ANDERE ZUBEHÖR / OTHER ACCESSORIES / AUTRES ACCESSOIRES

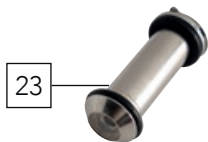

	Beschreibung / Description / Descriptif	AluStahl / Alusteel / Acier		Ref
		Aluminium	Holz / Timber / Bois	
1	Knaufgarnitur Edelstahl-Finish / Pull handle with stainless steel finish / Poignée de tirage finition inox	×		QPP-024-IN
2	Knaufgarnitur rund, Edelstahl-Finish / Round pull handle with stainless steel finish / Poignée de tirage ronde finition inox	×		QPP-020-IN
3	Knaufgarnitur grau, Bel'M-Dekor / Bel'M Deco Grey pull handle / Poignée de tirage Gris Déco Bel'M	×		QPP-024-GD
4	Knaufgarnitur rund, grau, Bel'M-Dekor / Bel'M Deco Grey round pull handle / Poignée de tirage ronde Gris Déco Bel'M	×		QPP-020-GD
5	Knaufgarnitur Edelstahl / Stainless steel pull handle / Poignée de tirage inox			QPP-021-IN
6	Sicherheitswechselgarnitur in Edelstahl RC2 / RC2 Stainless steel pull handle / Poignée de tirage inox RC2			QPP-027-IN
7	Stoßgriff rund, Farbe Edelstahl 1800 mm / Round pull bar in stainless steel colour, 1800 mm / Barre de tirage ronde couleur inox 1800 mm	●	● T-105 × T-201- T-203	QBT-005-IN
8	Stoßgriff rund, Farbe Edelstahl 950 mm / Round pull bar in stainless steel colour, 950 mm / Barre de tirage ronde couleur inox 950 mm	●	×	QBT-003-IN
9	Stoßgriff rechteckig, grau, Bel'M-Dekor, 930 mm / Bel'M Deco Grey rectangular pull handle 930 mm / Barre de tirage rectangle Gris Déco Bel'M 930 mm	×	● T-201- T-203	QBT-020-LAQ
10	Stoßgriff versetzt rund 400 mm / Round offset pull bar, 400 mm / Barre de tirage ronde déportée 400 mm			QBT-025-IN
11	Stoßgriff versetzt rund 950 mm / Round offset pull bar, 950 mm / Barre de tirage ronde déportée 950 mm			QBT-023-IN
12	Stoßgriff versetzt rund 950 mm / Round offset pull bar, 950 mm / Barre de tirage ronde déportée 950 mm			QBT-031-IN
13	Rosette Türzylinder Edelstahl verstärkt / Reinforced stainless steel security rosette / Rosace barillet inox renforcée	●		
14	Rosette Türzylinder Edelstahl verstärkt / Reinforced stainless steel security rosette / Rosace barillet inox renforcée			×
15	1/2 Knauf Design-Rosette, Edelstahlausführung innen, verbunden mit Stoßgriff / Stylish rosette 1/2 handle with stainless steel interior finish associated with a pull bar / 1/2 poignée rosace Design finition inox intérieur associée à une barre de tirage	●	●	QPR-023-IN
16	1/2 Knauf, Edelstahl, mit Rosette Türzylinder (innen), verbunden mit Stoßgriff / 1/2 stainless steel handle with cylinder rosette (interior) associated with a pull bar / 1/2 poignée inox avec rosace barillet (intérieur) associée à une barre de tirage			×
17	1/2 Knauf, Edelstahl, mit Rosette Sicherheits-Türzylinder (innen), verbunden mit Stoßgriff / 1/2 stainless steel handle with security cylinder rosette (interior) associated with an RC2 pull bar / 1/2 poignée inox avec rosace barillet de sécurité (intérieur) associée à une barre de tirage RC2			×
18	Knauf auf Edelstahlplatte / Handle on stainless steel plate / Poignée sur plaque inox			×
19	Edelstahl-waagerechter Stoßgriff / Stainless steel decorative pull bar / Bâton de maréchal inox	×		QBD-004-IN
20	Edelstahl-Briefkastenschlitz / Stainless steel letter box / Entrée de boîte aux lettres inox			×
21	Waagerechter Stoßgriff grau, Bel'M-Dekor / Bel'M Deco Grey decorative pull bar / Bâton de maréchal Gris Déco Bel'M	×		QDB-001-GD
22	Briefkastenschlitz grau, Bel'M-dekor / Bel'M Deco Grey letter box / Entrée de boîte aux lettres Gris Déco Bel'M	×		QBL-004-GD
23	Türspion / Peephole / Microviseur	×	×	×
24	Elektrischer Türöffner oder Elektrischer Türöffner mit Tagesentriegelung / Electric strike or swivel strike / Gâche électrique ou gâche pivotante	×		×

● Serienmäßige / As standard / De série × Optional / Optional / En option

VERGLASUNG

GLAZING

VITRAGE

VERGLASUNGSOPTIONEN / GLAZING OPTIONS / OPTIONS DE VITRAGE

Serienmäßige Verglasung, Merkmalen auf Seiten 121-122. Einige Änderungen sind möglich (bitte konsultieren Sie uns). Die folgenden Fotos sind Verglasungsbeispiele.

Standard glazing with characteristics as per catalogue index on p121-122. Some customisation possible (please contact us). Photos below show various glazing options.

Chaque modèle vitré est attribué d'un vitrage en standard dont les caractéristiques sont indiquées dans l'index du catalogue en page 121-122. Certaines modifications sont possibles en option (nous consulter). Les photos ci-dessous sont des exemples de vues.



Satinato / Sandblasted / Sablé



Ornament 504 / Classic patterned glass / Imprimé 200



Klarglas / Clear / Transparent



Master carre / Master-carré / Master carré



Frostglas / Frosted / Givré



Delta weiss / White Delta / Delta blanc

SICHERHEITVERGLASUNGEN / SAFETY GLAZING / VITRAGES DE SÉCURITÉ

P2A GLAS* /
P2A GLASS* /
VITRAGE CLASSE P2A*

Standardmäßig in allen AluStahl Modellen, sowie Aluminiumtüre Modell A 103 / Standard feature on steel models* and A-103 / En standard sur les modèles acier* et A-103

P5A GLAS* /
P5A GLASS* /
VITRAGE CLASSE P5A

Standardmäßig in allen Aluminium Modellen / Standard feature on aluminium models** / En standard sur les modèles aluminium**

VERBUNDVERGLASUNG /
LAMINATED DOUBLE GLAZING /
VITRAGE DOUBLE FEUILLETÉ

Nur im Vereinigten Königreich (bitte konsultieren Sie uns) / Solely in the UK (please contact us) / Uniquement sur le marché UK (nous consulter)

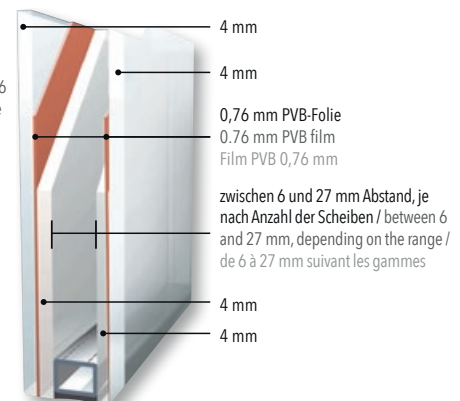
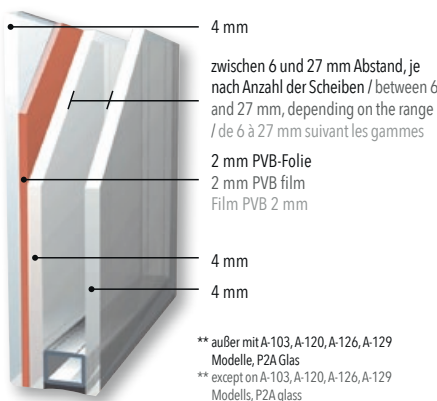
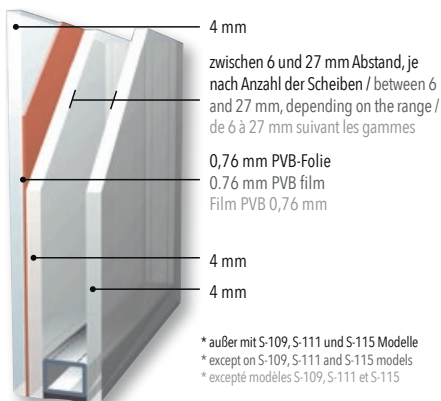

Beschreibung / Description / Descriptif		Leistung nach / Performance according to / Performances norme		Leistung / Performance in / Performances en		—	
		NF EN 14351-1		2150 x 900 mm			
Modell / Model / Modèle	Seite / Page	Produktpalette / Range / Gamme	Wärmedämmung / Thermal insulation / Isolation thermique	Schalldämmung / Acoustic insulation / Isolation acoustique	Luft, Wasser, Wind / Air, Water, Wind / Air, Eau et Vent	Verglasung / Glazing / Vitrage	
			Ud (W/m².K)*	[Rw (C,Ctr) dB]	AEV		
A-100	50	Aluminium 80	0,93	36(-2;-5)dB	A*4 E*6B V*C3		
A-101	50-51	Aluminium 80	0,93	36(-2;-5)dB	A*4 E*6B V*C3		
A-102	52	Aluminium 80	0,93	36(-2;-5)dB	A*4 E*6B V*C3		
A-103	30	Aluminium 80	1,1	36(-1;-4)dB	A*4 E*5B V*C3	Dreifachverglasung, sandgestrahlt, bündig, Klasse P2A Triple sandblasted flush glazing, P2A class Triple vitrage sablé affleurant classe P2A	
A-104	29	Aluminium 80	1,1	36(-1;-4)dB	A*4 E*5B V*C3		
A-105	38	Aluminium 80	1,1	36(-1;-4)dB	A*4 E*5B V*C3		
A-106	37	Aluminium 80	1,1	36(-1;-4)dB	A*4 E*5B V*C3		
A-107	34	Aluminium 80	1,1	36(-1;-4)dB	A*4 E*5B V*C3		
A-108	21	Aluminium 80	1,1	36(-1;-4)dB	A*4 E*5B V*C3		
A-109	48-49	Aluminium 80	0,93	36(-2;-5)dB	A*4 E*6B V*C3		
A-110	36	Aluminium 80	1,1	36(-1;-4)dB	A*4 E*5B V*C3		
A-111	28	Aluminium 80	1,1	36(-1;-4)dB	A*4 E*5B V*C3		
A-112	44-45	Aluminium 80	0,93	36(-2;-5)dB	A*4 E*6B V*C3		
A-114	35	Aluminium 80	1,1	36(-1;-4)dB	A*4 E*5B V*C3		
A-115	31	Aluminium 80	1,1	36(-1;-4)dB	A*4 E*5B V*C3		
A-117	34	Aluminium 80	1,1	36(-1;-4)dB	A*4 E*5B V*C3		
A-118	60-61	Aluminium 80	0,93	36(-2;-5)dB	A*4 E*6B V*C3		
A-119	40	Aluminium 80	1,1	36(-1;-4)dB	A*4 E*5B V*C3		
A-120	43	Aluminium 80	1,6	37(-1;-3)dB	A*3 E*4B V*C3		
A-121	54-55	Aluminium 80	0,93	36(-2;-5)dB	A*4 E*6B V*C3		
A-122	27	Aluminium 80	1,1	36(-1;-4)dB	A*4 E*5B V*C3		
A-123	41	Aluminium 80	1,1	36(-1;-4)dB	A*4 E*5B V*C3		
A-124	14-15	Aluminium 80	1,0	36(-1;-4)dB	A*4 E*5B V*C3		
A-125	16-17	Aluminium 80	1,1	36(-1;-4)dB	A*4 E*5B V*C3		
A-126	58-59	Aluminium 80	1,4	35(-1;-3)dB	A*3 E*4B V*C3		
A-127	39	Aluminium 80	1,1	36(-1;-4)dB	A*4 E*5B V*C3		
A-128	23	Aluminium 80	1,1	36(-1;-4)dB	A*4 E*5B V*C3		
A-129	32-33	Aluminium 80	1,2	from 34(0;-3)dB to 37(-1;-3)dB	A*3 E*4B V*C3		
A-130	42	Aluminium 80	1,1	36(-1;-4)dB	A*4 E*5B V*C3		
A-131	26	Aluminium 80	1,0	36(-1;-4)dB	A*4 E*5B V*C3		
A-132	22	Aluminium 80	1,1	36(-1;-4)dB	A*4 E*5B V*C3		
A-138	18	Aluminium 80	1,2	36(-1;-4)dB	A*4 E*5B V*C3		
A-139	19	Aluminium 80	1,1	36(-1;-4)dB	A*4 E*5B V*C3		
A-140	19	Aluminium 80	1,2	36(-1;-4)dB	A*4 E*5B V*C3		
A-141	20	Aluminium 80	1,0	36(-1;-4)dB	A*4 E*5B V*C3		
A-142	24-25	Aluminium 80	1,0	36(-1;-4)dB	A*4 E*5B V*C3		
A-143	46-47	Aluminium 80	0,93	36(-2;-5)dB	A*4 E*6B V*C3		
A-144	53	Aluminium 80	0,93	36(-2;-5)dB	A*4 E*6B V*C3		
A-145	56	Aluminium 80	0,93	36(-2;-5)dB	A*4 E*6B V*C3		
A-146	57	Aluminium 80	0,93	36(-2;-5)dB	A*4 E*6B V*C3		
S-100	96	AluStahl / Alusteel / Acier 48	1,0	29(-4;-5)dB	A*4 E*5B V*C3		
S-100+	96	AluStahl / Alusteel / Acier 68	0,75	30(-4;-6)dB	A*4 E*5B V*C3		
S-101	97	AluStahl / Alusteel / Acier 48	1,0	29(-4;-5)dB	A*4 E*5B V*C3		
S-101+	97	AluStahl / Alusteel / Acier 68	0,75	30(-4;-6)dB	A*4 E*5B V*C3		
S-102	94	AluStahl / Alusteel / Acier 48	1,0	29(-4;-5)dB	A*4 E*5B V*C3		
S-102+	94	AluStahl / Alusteel / Acier 68	0,75	30(-4;-6)dB	A*4 E*5B V*C3		
S-103	95	AluStahl / Alusteel / Acier 48	1,0	29(-4;-5)dB	A*4 E*5B V*C3		
S-103+	95	AluStahl / Alusteel / Acier 68	0,75	30(-4;-6)dB	A*4 E*5B V*C3		
S-104	92-93	AluStahl / Alusteel / Acier 48	1,0	29(-4;-5)dB	A*4 E*5B V*C3		
S-104+	92-93	AluStahl / Alusteel / Acier 68	0,75	30(-4;-6)dB	A*4 E*5B V*C3		
S-105	98	AluStahl / Alusteel / Acier 48	1,2	from 29(-4;-5)dB to 33(-2;-4)dB	A*3 E*3B V*C3	Doppelverglasung, sandgestrahlt Double sandblasted glazing Double vitrage sablé	
S-105+	98	AluStahl / Alusteel / Acier 68	0,84	from 30(-4;-6)dB to 34(-3;-5)dB	A*3 E*3B V*C3		
S-106	84-85	AluStahl / Alusteel / Acier 48	1,0	29(-4;-5)dB	A*4 E*5B V*C3		
S-106+	84-85	AluStahl / Alusteel / Acier 68	0,75	30(-4;-6)dB	A*4 E*5B V*C3		
S-108	99	AluStahl / Alusteel / Acier 48	(1,3)	from 29(-4;-5)dB to 33(-2;-4)dB	A*3 E*3B V*C3		
S-108+	99	AluStahl / Alusteel / Acier 68	1,2	from 30(-4;-6)dB to 34(-3;-5)dB	A*3 E*3B V*C3		
S-109	83	AluStahl / Alusteel / Acier 48	1,1	from 29(-4;-5)dB to 33(-2;-4)dB	A*3 E*3B V*C3	Doppelverglasung, sandgestrahlt Double sandblasted glazing Double vitrage sablé	

() Derzeit laufende zertifizierte Versuche / Ongoing certification tests / Essais certifiés en cours

Dreifachverglasung, sandgestrahlt, bündig, Klasse P5A / Triple sandblasted flush glazing, P5A class / Triple vitrage sablé affleurant classe P5A

Doppelverglasung, sandgestrahlt, Klasse P2A / Double sandblasted glazing, P2A class / Double vitrage sablé classe P2A

Beschreibung / Description / Descriptif			Leistung nach / Performance according to / Performances norme		Leistung / Performance in / Performances en		—	
			NF EN 14351-1		2150 x 900 mm			
Modell / Model / Modèle	Seite / Page	Produktpalette / Range / Gamme	Wärmedämmung / Thermal insulation / Isolation thermique		Schalldämmung / Acoustic insulation / Isolation acoustique		Luft, Wasser, Wind Air, Water, Wind Air, Eau et Vent	
			Ud (W/m².K)*		[Rw (C,Ctr) dB]		AEV	
S-109+	83	AluStahl / Alusteel / Acier 68	(0,82)		from 30(-4;-6)dB to 34(-3;-5)dB		A*3 E*3B V*C3	
S-110	71	AluStahl / Alusteel / Acier 48	(1,4)		from 29(-4;-5)dB to 33(-2;-4)dB		A*3 E*3B V*C3	
S-110+	71	AluStahl / Alusteel / Acier 68	1,0		from 30(-4;-6)dB to 34(-3;-5)dB		A*3 E*3B V*C3	
S-111	82	AluStahl / Alusteel / Acier 48	1,1		from 29(-4;-5)dB to 33(-2;-4)dB		A*3 E*3B V*C3	
S-111+	82	AluStahl / Alusteel / Acier 68	(0,82)		from 30(-4;-6)dB to 34(-3;-5)dB		A*3 E*3B V*C3	
S-112	66-67	AluStahl / Alusteel / Acier 48	(1,4)		from 29(-4;-5)dB to 33(-2;-4)dB		A*3 E*3B V*C3	
S-112+	66-67	AluStahl / Alusteel / Acier 68	1,1		from 30(-4;-6)dB to 34(-3;-5)dB		A*3 E*3B V*C3	
S-113	69	AluStahl / Alusteel / Acier 48	(1,4)		from 29(-4;-5)dB to 33(-2;-4)dB		A*3 E*3B V*C3	
S-113+	69	AluStahl / Alusteel / Acier 68	1,1		from 30(-4;-6)dB to 34(-3;-5)dB		A*3 E*3B V*C3	
S-114	71	AluStahl / Alusteel / Acier 48	(1,4)		from 29(-4;-5)dB to 33(-2;-4)dB		A*3 E*3B V*C3	
S-114+	71	AluStahl / Alusteel / Acier 68	1,1		from 30(-4;-6)dB to 34(-3;-5)dB		A*3 E*3B V*C3	
S-115	72	AluStahl / Alusteel / Acier 48	1,5		from 29(-4;-5)dB to 33(-2;-4)dB		A*3 E*3B V*C3	
S-115+	72	AluStahl / Alusteel / Acier 68	1,2		from 30(-4;-6)dB to 34(-3;-5)dB		A*3 E*3B V*C3	
S-116	80-81	AluStahl / Alusteel / Acier 48	1,8		33(-2;-4)dB		A*3 E*3B V*C3	
S-116+	80-81	AluStahl / Alusteel / Acier 68	(1,3)		34(-3;-5)dB		A*3 E*3B V*C3	
S-117	79	AluStahl / Alusteel / Acier 48	1,8		33(-2;-4)dB		A*3 E*3B V*C3	
S-117+	79	AluStahl / Alusteel / Acier 68	(1,3)		34(-3;-5)dB		A*3 E*3B V*C3	
S-118	68	AluStahl / Alusteel / Acier 48	1,4		from 29(-4;-5)dB to 33(-2;-4)dB		A*3 E*3B V*C3	
S-118+	68	AluStahl / Alusteel / Acier 68	1,1		from 30(-4;-6)dB to 34(-3;-5)dB		A*3 E*3B V*C3	
S-119	74-75	AluStahl / Alusteel / Acier 48	1,3		from 29(-4;-5)dB to 33(-2;-4)dB		A*3 E*3B V*C3	
S-119+	74-75	AluStahl / Alusteel / Acier 68	1,1		from 30(-4;-6)dB to 34(-3;-5)dB		A*3 E*3B V*C3	
S-120	70	AluStahl / Alusteel / Acier 48	(1,2)		Contact us		(A*4 E*5B V*C3)	
S-120+	70	AluStahl / Alusteel / Acier 68	0,91		Contact us		(A*4 E*5B V*C3)	
S-121	73	AluStahl / Alusteel / Acier 48	(1,2)		Contact us		(A*4 E*5B V*C3)	
S-121+	73	AluStahl / Alusteel / Acier 68	0,85		Contact us		(A*4 E*5B V*C3)	
S-128	89	AluStahl / Alusteel / Acier 48	1,0		29(-4;-5)dB		A*4 E*5B V*C3	
S-128+	89	AluStahl / Alusteel / Acier 68	0,75		30(-4;-6)dB		A*4 E*5B V*C3	
S-129	90	AluStahl / Alusteel / Acier 48	1,0		29(-4;-5)dB		A*4 E*5B V*C3	
S-129+	90	AluStahl / Alusteel / Acier 68	0,75		30(-4;-6)dB		A*4 E*5B V*C3	
S-130	91	AluStahl / Alusteel / Acier 48	1,0		29(-4;-5)dB		A*4 E*5B V*C3	
S-130+	91	AluStahl / Alusteel / Acier 68	0,75		30(-4;-6)dB		A*4 E*5B V*C3	
S-131	88	AluStahl / Alusteel / Acier 48	1,0		29(-4;-5)dB		A*4 E*5B V*C3	
S-131+	88	AluStahl / Alusteel / Acier 68	0,75		30(-4;-6)dB		A*4 E*5B V*C3	
S-132	86-87	AluStahl / Alusteel / Acier 48	1,0		29(-4;-5)dB		A*4 E*5B V*C3	
S-132+	86-87	AluStahl / Alusteel / Acier 68	0,75		30(-4;-6)dB		A*4 E*5B V*C3	
S-133	76	AluStahl / Alusteel / Acier 48	1,3		Contact us		(A*4 E*5B V*C3)	
S-133+	76	AluStahl / Alusteel / Acier 68	(1,1)		Contact us		(A*4 E*5B V*C3)	
S-134	77	AluStahl / Alusteel / Acier 48	1,3		Contact us		(A*4 E*5B V*C3)	
S-134+	77	AluStahl / Alusteel / Acier 68	(1,0)		Contact us		(A*4 E*5B V*C3)	
S-135	78	AluStahl / Alusteel / Acier 48	1,3		Contact us		(A*4 E*5B V*C3)	
S-135+	78	AluStahl / Alusteel / Acier 68	(1,1)		Contact us		(A*4 E*5B V*C3)	
T-101	114	Holz / Timber / Bois	(0,76)		32(0;-2)dB		A*3 E*6B V*C3	
T-102	112	Holz / Timber / Bois	(0,76)		32(0;-2)dB		A*3 E*6B V*C3	
T-103	110-111	Holz / Timber / Bois	(0,76)		32(0;-2)dB		A*3 E*6B V*C3	
T-105	109	Holz / Timber / Bois	(0,80)		32(0;-3)dB		A*3 E*6B V*C3	
T-108	113	Holz / Timber / Bois	(0,76)		32(0;-2)dB		A*3 E*6B V*C3	
T-201	108	Holz / Timber / Bois	(0,81)		32(0;-2)dB		A*3 E*6B V*C3	
T-202	106-107	Holz / Timber / Bois	(0,81)		32(0;-2)dB		A*3 E*6B V*C3	
T-203	104-105	Holz / Timber / Bois	(0,83)		32(0;-2)dB		A*3 E*6B V*C3	

() Derzeit laufende zertifizierte Versuche / Ongoing certification tests / Essais certifiés en cours

 Dreifachverglasung, sandgestrahlt, bündig, Klasse P5A / Triple sandblasted flush glazing, P5A class / Triple vitrage sablé affleurant classe P5A

 Doppelverglasung, sandgestrahlt, Klasse P2A / Double sandblasted glazing, P2A class / Double vitrage sablé classe P2A

GARANTIEN UND LABEL

WARRANTIES AND CERTIFICATIONS



LES GARANTIES ET LABELS

GARANTIEN / WARRANTIES / LES GARANTIES*

	Baureihen Ranges Gammes	Aluminium	Holz / Timber / Bois T-201 ; 202 ; 203	Lackiertes oder gebeiztes Holz Lacquered or stained timber Bois laqué ou lasuré	AluStahl / Alusteel / Acier			
 AUSFÜHRUNG RAHMEN FRAME FINISH FINITION DORMANT	Korrosionsschutz Anti-corrosion Anti-corrosion	10 years	Outer frame 10 years	-	10 years			
	Glanz/Farbe Gloss/Colour Brilliance / Couleur	10 years	Outer frame 10 years  Inner frame 3 years	3 years*	Lackierung Weiß / Lackered in white / Laqué Blanc 9016.5	Lackierung Seidenmatt / Satined Lackered / Laqué satiné	Lackierung Feinstruktur / Textured Lackered / Laqué Texture	Unbegrenzte Auswahl für Lackierung in RAL-Farbtönen / Lackered in any RAL colour / Laqué RAL couleurs illimitées
 AUSFÜHRUNG TÜRBLATT DOOR SASH FINISH FINITION OUVRANT	Rotschutz Anti-corrosion Anti-corrosion	10 years	-	-	10 years			
	Glanz/Farbe Gloss/Colour Brilliance / Couleur	10 years	3 years*	3 years*	10 years	7 years	5 years	3 years
 AUSFÜHRUNG ZUBEHÖR UND BESCHLÄGE ACCESSORIES AND HARDWARE FINISH FINITION ACCESSOIRES ET QUINCAILLERIES					2 years			
 GARANTIE AUF MECHANISCHE FUNKTION/ DICHTHEIT MECHANICAL/ WATERPROOF GUARANTEE GARANTIE DE FONCTIONNEMENT MÉCANIQUE / ÉTANCHÉITÉ	Rahmen Frame Dormant				10 years			
	Türblatt Door Ouvrant				10 years			
	Beschläge Hardware Quincaillerie				10 years			
	Schloss Locking system Serrure				5 years			
	Verglasung Glazing Vitrage				10 years			

* Ausnahmen: Eiche lasiert 2 Jahre / Except: Stained oak 2 years / Sauf : Chêne lasuré 2 ans.

GÜTESIEGEL / QUALITY LABELS / LABELS QUALITÉ

 Licence n° 554	<p>DAS QUALICOAT-LABEL garantiert die Prozessqualität der Pulverbeschichtung und deren Beständigkeit. Seit 1995 nach diesem Label zertifiziert. / THE QUALICOAT CERTIFICATION attests to the quality and durability of the powder coating process. Certification obtained in 1995. / LE LABEL QUALICOAT atteste de la qualité du process de thermolaquage et la tenue dans le temps. Label obtenu dès 1995.</p>
 Agreement n° QMP-1129	<p>DAS QUALIMARINE-LABEL: Dies ist eine weitere Zertifizierung neben dem Qualicoat®-Label, mit dem vor der Lackierung die Qualität der Oberflächenbehandlung von besonderes beanspruchten Profilen (z. B. durch Seeluft oder in Industriegebieten) attestiert wird. Seit 2004 nach diesem Label zertifiziert. / THE QUALIMARINE CERTIFICATION: Complementary to the Qualicoat® certification, it certifies the surface treatment before powder coating of profiles intended for more severe exposure (seaside, industrial areas, etc.) before painting. Certification obtained in 2004. / LE LABEL QUALIMARINE : Complémentaire au label Qualicoat® certifie avant laquage, le traitement de surface des profils destinés à une exposition plus sévère (bord de mer, zones industrielles, ...). Label obtenu dès 2004.</p>
 Label qualité international pour l'acier peint:	<p>DAS QUALISTEELCOAT-LABEL: Internationales Qualitätslabel für Stahl mit Anstrich (das Äquivalent zur Qualicoat®-Zertifizierung für Aluminium), mit dem Korrosionsbeständigkeit und die gute Farbanhaftung auf dem Stahl garantiert werden. Seit 2012 nach diesem Label zertifiziert. / THE QUALISTEELCOAT CERTIFICATION: International Quality Label for coated steel (equivalent to Qualicoat® for aluminium) guarantees the corrosion resistance and durability of the coating on steel. Certification obtained in 2012. / LE LABEL QUALISTEELCOAT : Label de Qualité international pour l'acier peint (équivalent de Qualicoat® pour l'aluminium) garanti l'anticorrosion et la bonne tenue du laquage sur l'acier. Label obtenu dès 2012.</p>

* Diese Gewährleistung kann nur in Anspruch genommen werden, wenn alle Empfehlungen für Einbau und Instandhaltung genauestens befolgt werden. Die Garantie ist auf den Ersatz defekter Teile in dem Zustand beschränkt, in dem sie geliefert wurden, oder aber auf deren Reparatur, wenn von uns offiziell ein Fertigungsfehler festgestellt wurde.

* These warranties applies only if products are installed and maintained according to seller recommended practices and fitting instructions. The warranty is limited to the replacement or repair of parts which we find to be defective due to faulty materials or workmanship.

* Ces garanties ne peuvent jouer que si toutes les recommandations de pose et d'entretien sont respectées strictement. La garantie se limite au remplacement, dans leur état de livraison, ou à la réparation des éléments défectueux constitutifs à un vice de fabrication reconnu constaté par nos services.

FINDEN SIE ALLE UNSERE MODELLE AUF DER BEL-M.DE WEBSITE

FIND ALL OUR MODELS ON THE BEL-M.COM WEBSITE

RETROUVEZ L'ENSEMBLE DE NOS MODÈLES SUR LE SITE BEL-M.COM



PEFC certified. This product comes from sustainably managed forests and controlled sources / www.pefc.org

Non-contractual document. Data subject to change. Please consult bel-m.de or bel-m.com for our latest updates. In the interest of improvement, our models are subject to change without notice.
Design: elvistheagence.fr - Photos: Stéphane Rambaud and D3 Studio - Printer IMPRIMERIE POLLINA - 09/2019